



### Advisories

Must be installed by a licensed professional.  
Overtightening could compromise circulation.  
Lace will wear:

- Routinely check for wear or damage.
- Look for broken fibers around areas of high wear.
- Replace lace if a significant amount of fibers are broken.
- Proactively replace lace every 6 months.
- Keep lace away from open flame and sharp edges.

**Weight limit:** 300lbs/135kg

See instructions in other languages: [clickmedical.co/instructions](http://clickmedical.co/instructions)

### GUARANTEE

The Click Reel is guaranteed to last the life of the device into which it is originally installed. Registration of the Click Reel is recommended at the time of original device delivery. To register: [clickmedical.co/contact-us/cr-registration/](http://clickmedical.co/contact-us/cr-registration/)

### WARRANTY

For warranty information on all of Click Medical's products: [clickmedical.co/terms/#warranty](http://clickmedical.co/terms/#warranty)

### U.S. Customers:

Contact [Help@ClickMedical.co](mailto:Help@ClickMedical.co)  
Tel: +1-970-670-7012

### International Customers:

Please contact your local distributor.

**Click Medical products are patent protected.**

For full list see [www.clickmedical.co/patents](http://www.clickmedical.co/patents)

## RevoSurface® Tool Kit Contents:

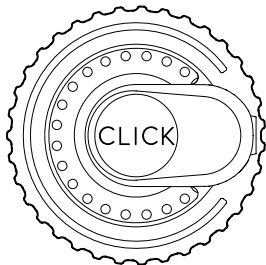

Click Reel

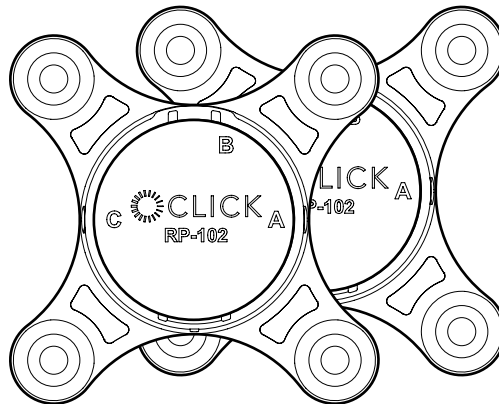

Surface Collar x 2

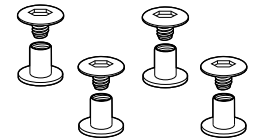

Chicago Screw x 4

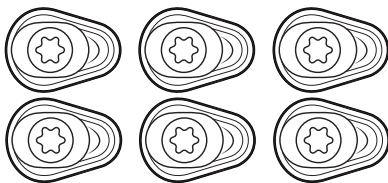

Surface Guide + Attachment Screw x 6

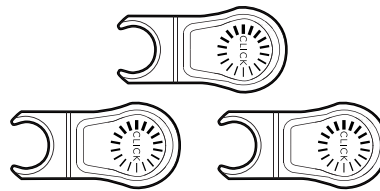

Releasing Tab x 3



Reel Tool

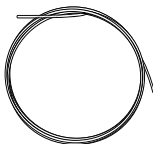

2.0m HC Lace



Plastic Lace Feeder x 3

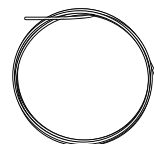

Metal Lace Feeder

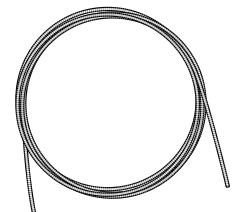

1.8m Lamination Tube

# Select the Application

## Thermoplastic

Use these instructions if you are building a thermoplastic diagnostic prosthesis.

### Option 1:

System wrapped in fiberglass for higher precision and durability or extended use.

[Go to Page 3](#)

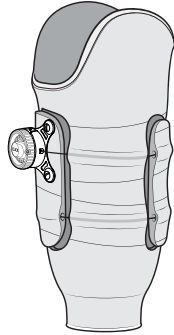

### Option 2:

System fastened with externally mounted hardware to quickly build and assess an adjustable design.

[Go to Page 7](#)

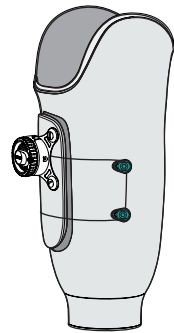

## 3D Print

Use these instructions if you are building a 3D printed device.

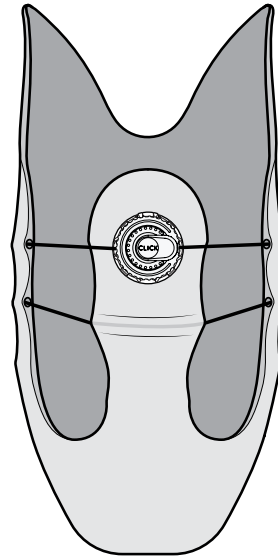

[Go to Page 13](#)

## Orthotics

Use these instructions if you are building an orthosis with adjustability.

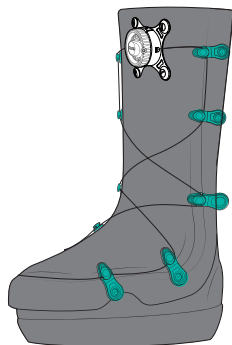
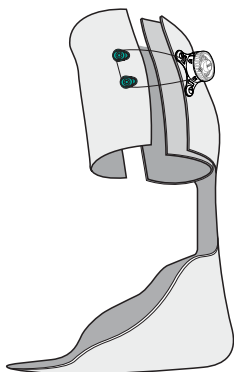

[Go to Page 7](#)

## Modifying an Existing Device

Use these instructions if you are adding adjustability to an existing device.

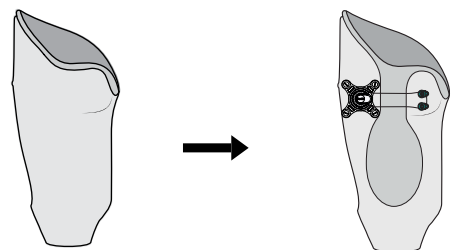
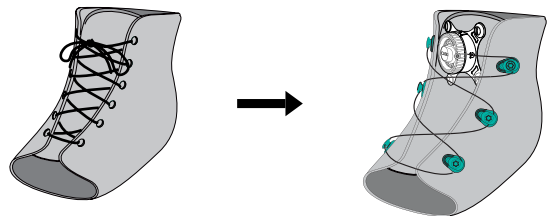

[Go to Page 7](#)

## Thermoplastic

Use these instructions if you are building a thermoplastic diagnostic prosthesis

System wrapped in fiberglass for higher precision and durability or extended use

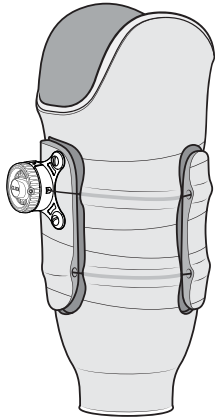

## Fabrication Overview:

1. Determine adjustable design type: Panel, Gap, Hinge.
2. Determine areas of adjustment and location of Click Reel.
3. Pull flexible insert material over mold.
4. Pull plastic over insert.
5. Draw areas of adjustment and location of Click Reel on device.
6. Attach RevoSurface components to device.
7. Wrap all parts of the system in cast tape.
8. Cut trim lines and areas of adjustment.
9. Sand and finish edges.
10. Apply pad material.
11. Lace device.
12. Install Click Reel and test for function.
13. Deliver to patient and optimize fit.

For material suggestions and guidelines, please refer to the **Material Data Sheet**: [clickmedical.co/mds](http://clickmedical.co/mds)

## Determine Adjustable Design Type:

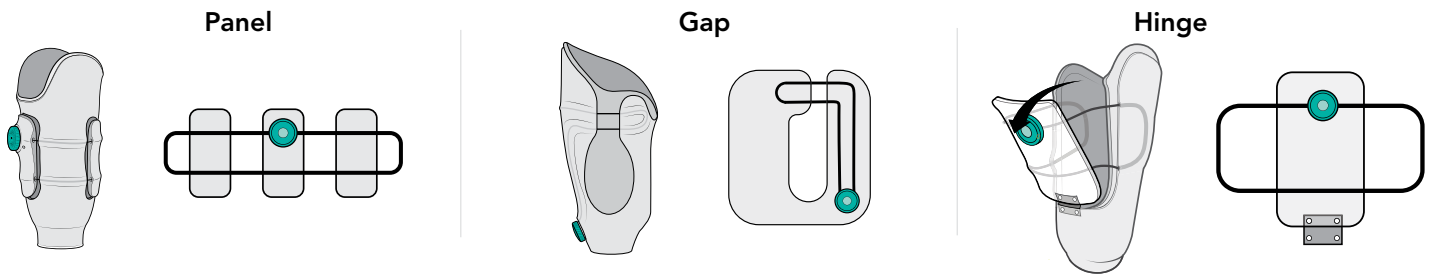

**Additional Designs:** To learn more about designing adjustable RevoSurface devices, enroll in [ClickAcademy.co](http://ClickAcademy.co)

## Detailed Fabrication Instructions:

- 1** Pull insert material over mold.

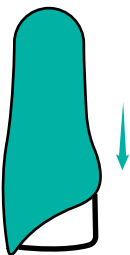

- 2** Pull plastic.

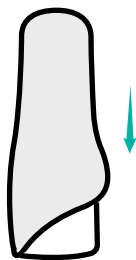

- 3** Remove device from model and attach necessary hardware to test on the patient.

- a. Verify volume and fit.

- 4** Determine location of Click Reel:

- a. Discuss with the patient where they would like the reel. Consider range of motion and accessibility.

- 5** Determine ideal adjustment areas.

### For Panel and Hinge designs:

1. Insert pads of approximate size and thickness into the device (one at a time) and don the device onto the patient.
2. Get feedback from the patient about fit.
3. Adjust pad size, position, and thickness as needed.
4. Mark final pad location, size and thickness on the device.

### For Gap designs:

1. Determine the gap size and location.
2. Mark on device.

## Detailed Fabrication Instructions:

### 6 Draw lace routing onto socket:

#### PANEL DESIGN RULE:

- $\frac{1}{4}$  rule = length of panel  $\div 4$ . Tube must be  $\frac{1}{4}$  distance from top/bottom edges.
- Tubes must cross panel parallel to each other.
- Tube must cross panel at a perpendicular angle to edge.
- Tube must extend 1cm on the frame before turning.

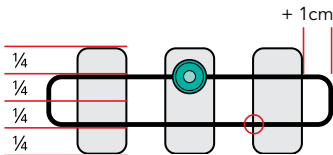

#### GAP DESIGN RULE:

- Tubes must cross gap parallel with each other.
- Tube must cross gap at a perpendicular angle to edge.
- Tube must extend straight 1cm on the frame before turning.

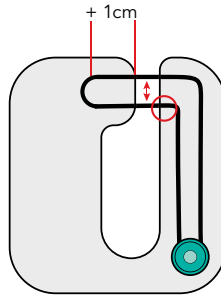

#### HINGE DESIGN RULE:

- Use  $\frac{1}{4}$  rule to determine where to route closure points.
- Tube must extend 1cm on the frame before turning.
- Hinge must be at a different level (in the transverse plane) than closure points.

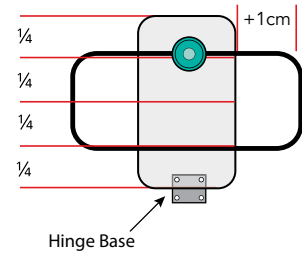

### 7 Align tube ports with lace path and bond or screw Surface Collar to device.

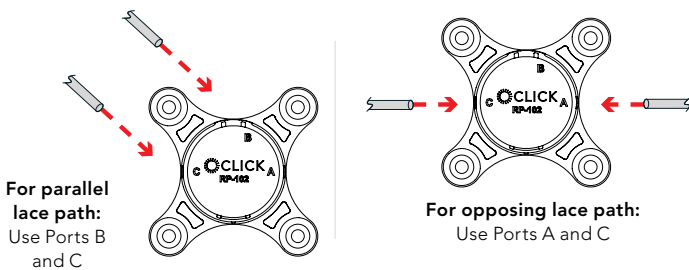

### 8 Glue tube to device frame.

Glue along designated path with dots of super glue about every 2cm.

**- DO NOT KINK THE TUBE -**  
If the tube kinks, you must replace with a new piece.

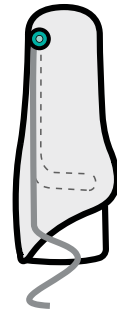

### 9 Take photo of trim lines and areas of adjustment for future reference.

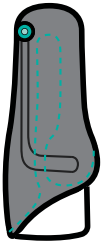

- ### 10 Sand surface and wrap entire system with cast tape. Cut tape away to expose collar and opening for retention tab.
- Hint:** Immediately wrap with cling wrap to ensure a tight bond and smooth finish.

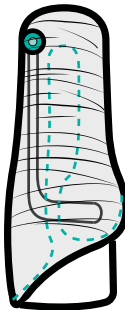

### 11 Re-draw trim lines and areas of adjustment.

Use photo from Step 8 for reference.

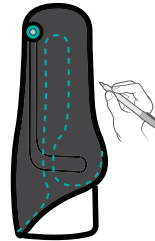

### 12 Cut trim lines.

Use small end of segmented cast saw blade for tight turns.

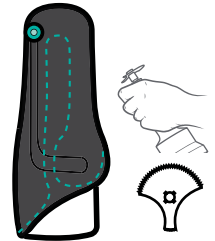

### 13 Finish edges of frame and/or panels:

- Sand edges.
- Clear tube ends of debris.
- Buff edges smooth with 1000 grit sandpaper.

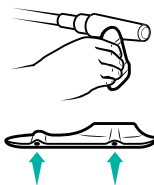

### 14 Prepare collar:

- Cut out fiberglass material covering the collar.
- Trim tube ends and clear debris.



- ### 15 Add pad material to panels or hinge designs.
- For more information in pad optimization, enroll in [Click Academy](#).

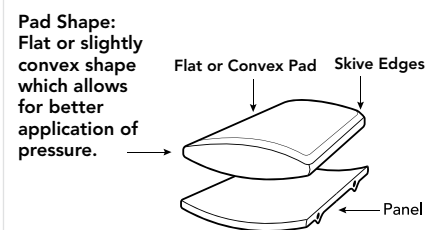

### 16 Lace device.

Start at the collar and use the lace feeder to pull lace through the device.

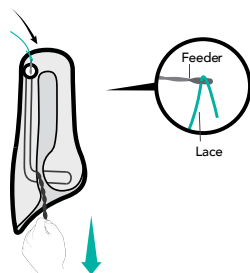

## Detailed Fabrication Instructions (continued):

### 17 Attach lace to the Click Reel:

#### Step 1

Ensure that the reel is ready for lacing. Both lock plugs should be in place. The **green marks** on the spool should align with the **green marks** on the washer. If necessary, turn dial to align **green marks**.

Adjust alignment by turning dial

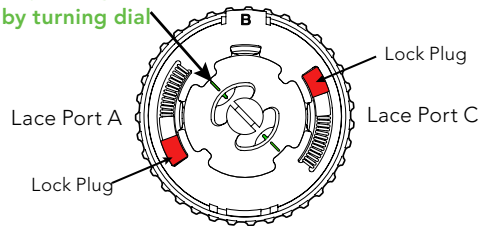

#### Step 2

Lace the device. Attach each lace to its corresponding lace port on the reel - A, B, or C.

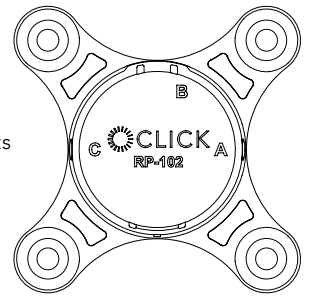

#### Step 3

Lace the reel using the plastic lace feeder.

#### Pro Tip:

Gently pull the lace through the cavity to avoid breaking the plastic lace feeder.

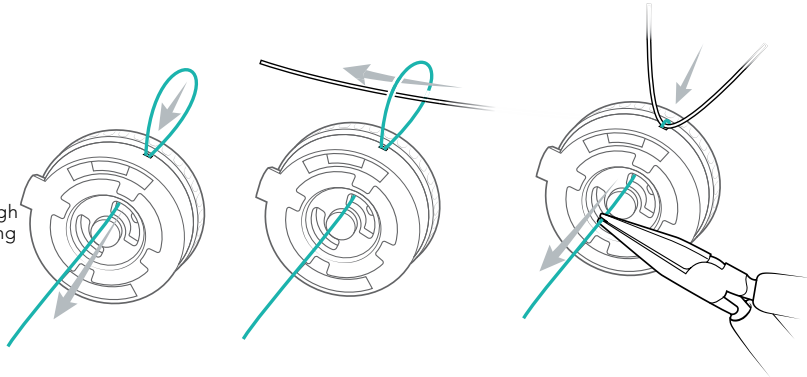

#### Step 4

Tie a **double overhand knot** and trim tail to ~5mm and lightly burn the end of the tail.

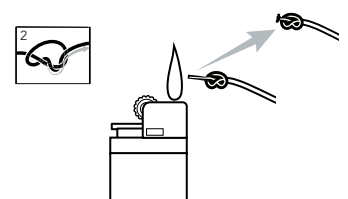

#### Step 5

Pull lace to seat knot in the far lace pocket, on the opposite side of the **green marker**.

**Completely push knot into the cavity with a #1 flathead screwdriver:**

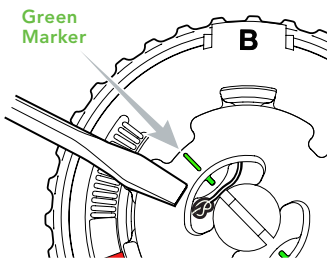

#### Step 6

Pull open lace end to remove loose lace from device.

Repeat Step 3 to feed open lace end through reel.

Measure out ~10cm of lace.

Repeat Step 4 to tie double overhand knot, trim and seat it.

#### Step 7

### Decide which reel mode to activate:

For more information on reel modes, watch our video here: <http://vimeo.com/7869809811>

ADJUSTABLE DESIGNS WITH **Less than 3" of lace uptake**

75% of Applications



Keep Red Lock Plugs installed in the reel

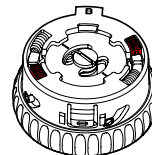

ADJUSTABLE DESIGNS WITH **More than 3" of lace uptake**

25% of Applications

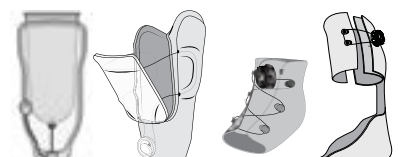

Remove Red Lock Plugs after lacing the reel.

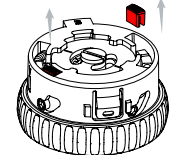

**Pro Tip:** CFABs should deliver device with Red Lock Plugs installed in reel. This will allow the practitioner to decide if they want Power Mode or Shift Mode.

### 18 Install the Click Reel:

1. Insert the foot of the reel into the void in the bottom of the collar opposite of the metal insert.

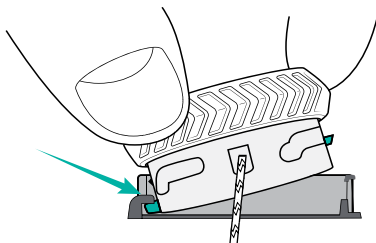

2. Press the reel firmly into the collar (you should hear a "CLICK" when secure).

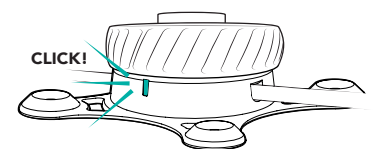
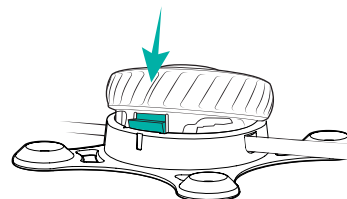

### 19 Test function.

Cycle the system 3 times before delivering to verify proper function.

### 20 Important.

As a final step of fabrication, attach the patient **Instructions For Use** hangtag on dial.

# How to use the Click Reel

- 1 Turn reel clockwise to quickly take up lace.



Fast Wind or Full Release  
Mode = Silent (Smooth)

- 2 Reel will automatically shift to high power mode as it tightens.



Power Mode =  
"Clicking" (Tactile)

- 3 Micro-adjust by turning forward or backward.



**Pro Tip:** If you prefer the reel to operate ONLY in Power Mode for constant micro-adjustment, replace the lock plug to "disable" the Shift function.

- 4 To fully release, unwind counterclockwise until "clicking" stops.



## To remove the Click Reel:

- Locate the metal insert.
- Insert a small #1 flathead screwdriver between the metal insert and the reel body.
- Gently pry the reel upwards.

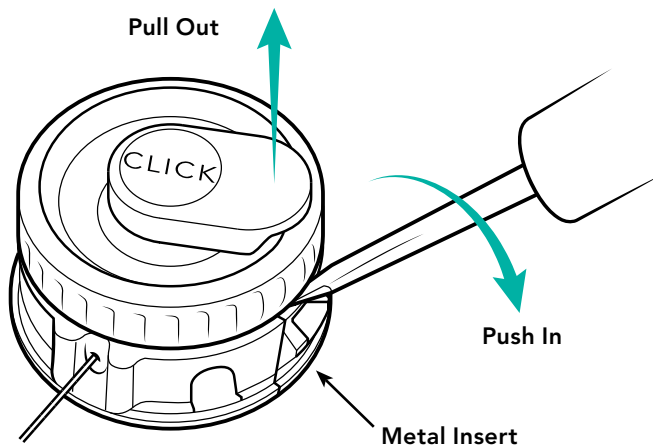

See [clickmedical.co/instructions](http://clickmedical.co/instructions) for detailed video instructions for replacing/re-lacing a reel.

## Teach your patients to care for and maintain their RevoSurface® system:

### Regularly inspect your RevoSurface system.



#### Inspect lace:

- ✓ Check for wear or damage routinely
- ✓ Replace at any sign of wear
- ✓ Replace lace every 6 months



This product is waterproof and submersible. Rinse with fresh water after use in saltwater, sand, or mud.

**UK REP**

MDSS-UK RP LIMITED, 6 Wilmslow Road  
Rusholme, M14 5TP Manchester  
United Kingdom

**CH REP**

MDSS CH GmbH, Laurenzenvorstadt 61  
5000 Aarau, Switzerland

**MD**

MDSS GmbH, Schiffgraben 41  
30175 Hannover, Germany

**EC REP**



Click Medical, LLC, 1205 Hilltop Parkway, W101  
Steamboat Springs, CO 80487, USA +1-970-670-7012

## Thermoplastic

Use these instructions if you are building a thermoplastic diagnostic prosthesis system fastened with **externally mounted hardware** to quickly build and assess an adjustable design.

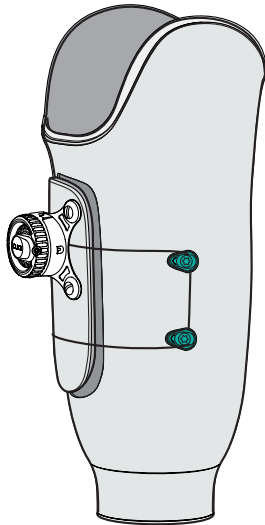

## Orthotics

Use these instructions if you are building an orthosis with adjustability.

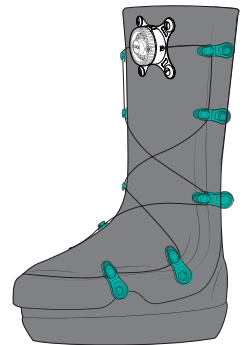
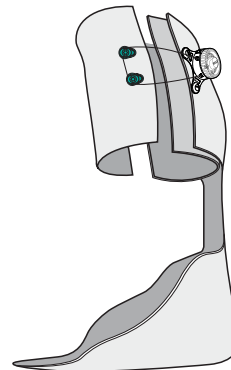

## Modifying an Existing Device

Use these instructions if you are adding adjustability to an existing device.

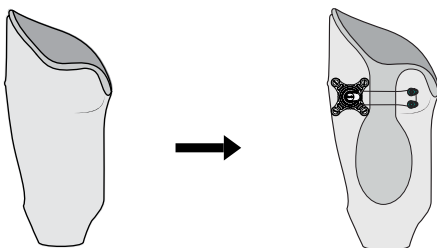
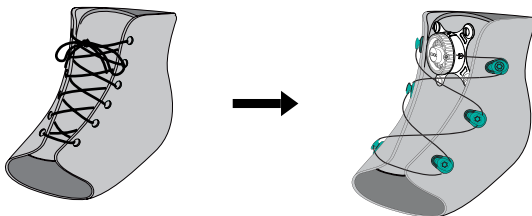

### Fabrication Overview:

1. Determine adjustable design type: Strap or Lacer.
2. Determine areas of adjustment and location of Click Reel.
3. Determine likely lace guide placements and mark their location on the device.
4. Attach RevoSurface components to device.
5. Lace device.
6. Install Click Reel and test for function.
7. Deliver to patient and optimize fit.

For material suggestions and guidelines, please refer to the **Material Data Sheet**: [clickmedical.co/mds](http://clickmedical.co/mds)

## Pick a Design:

**Additional Designs:** To learn more about designing adjustable RevoSurface® devices, enroll in [ClickAcademy.co](https://www.clickacademy.co)

### Strap

There are 3 strap configurations to choose from:

#### 1 Simple Straps

For volume adjustments and simple don/doff.

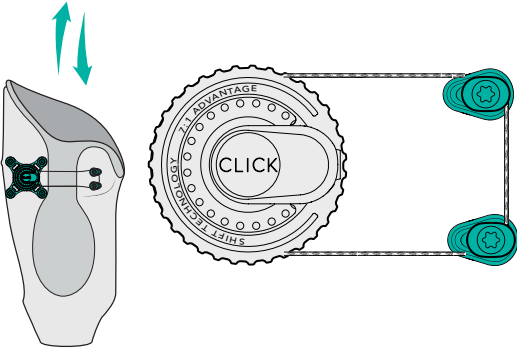

#### 2 Releasing Straps

For fully opening.

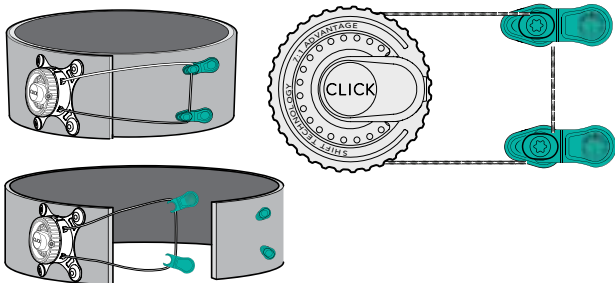

#### 3 Dynamic Straps

For fitting conical shapes or closing a larger device.

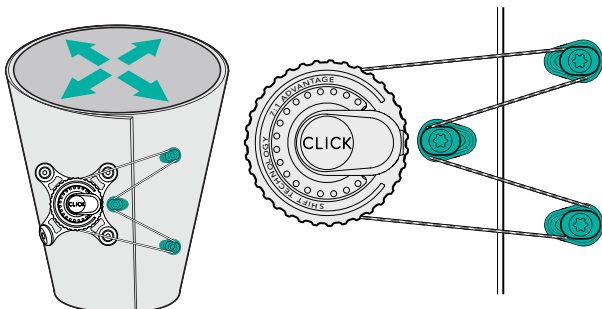

Dynamic strap can also be made with releasing guides to fully open.

### Lacer

There are 2 lacer configurations to choose from:

#### 1 Fixed Lacer

For easily slipping on/off the body.

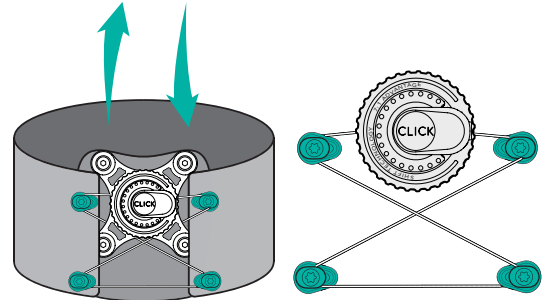

#### 2 Releasing Lacer

For fully opening a device.

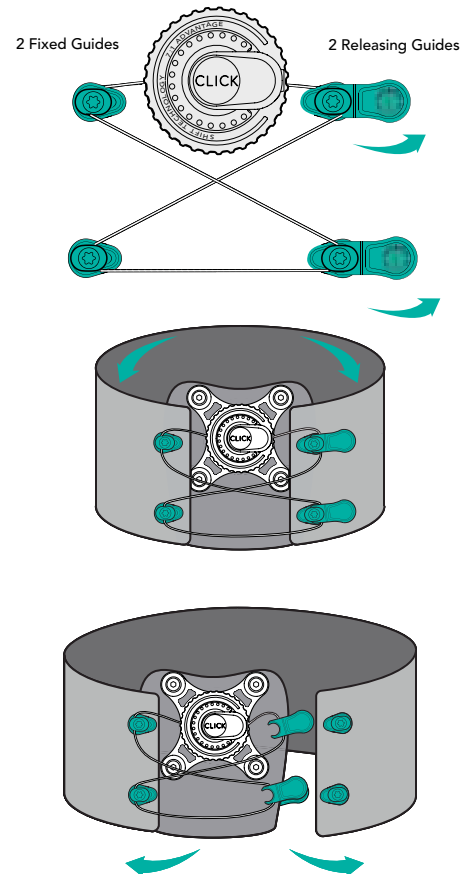

## Planning the Configuration:

- 1 For all designs, first determine the trim lines of the device and sketch on device.
- 2 Next, determine where you want to place the Click Reel:
  - a. Make sure it is in line with your likely lace path.
  - b. Ensure that the reel will be easily accessible by the patient.
  - c. Place the Click Reel so it will not protrude and catch on clothing or edges.



- 3 Optimize the design:
  - a. Determine likely lace guide placements and mark their location on the device.
  - b. Optimize the lace angles.
  - c. Pair guides where possible to span larger areas.

### For the Dynamic Strap:

Place the middle guide close to the reel to create optimal lace angles.

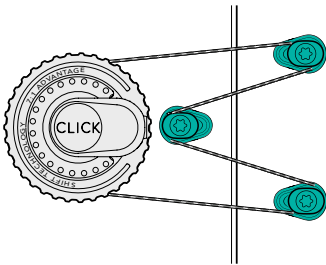

### For the Simple Strap:

Parallel laces are best.

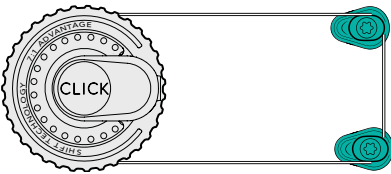

Place guides such that the lace angles are as minimal as possible to create optimum closure force.

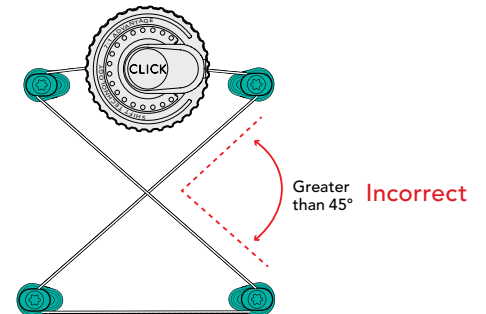
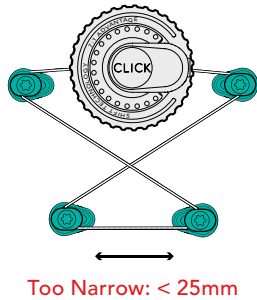
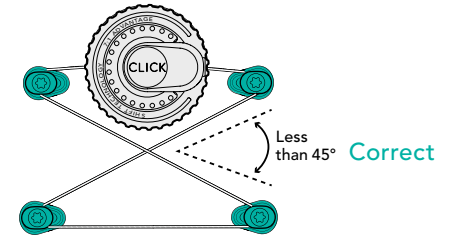
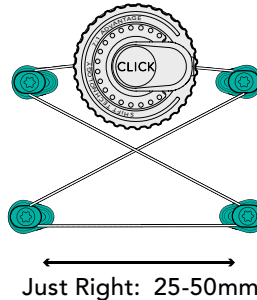

Single guides create closure over a smaller area.

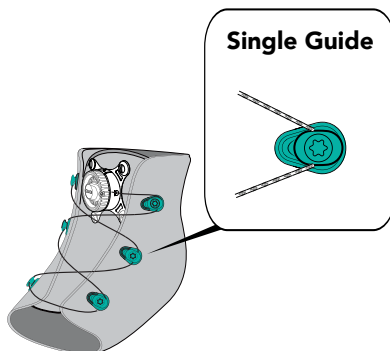

Paired guides span larger distances.

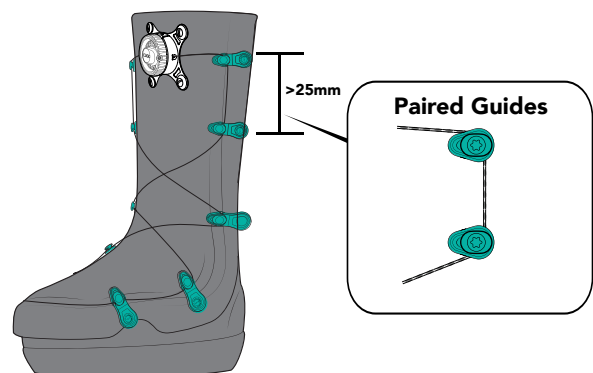

! Plan your configuration well before starting to mount components!  
It will save you time later.

## Fabricating the Device:

### 1 Mount the Surface Collar:

- Determine ideal placement.
- Grind a small flat area if the device has a small circumference.
- Mark and drill one of the holes, using a 3mm drill bit.
- Attach one arm of collar with a Chicago Screw.
- Mark other holes, rotate collar out of the way, drill holes and attach Chicago Screws.

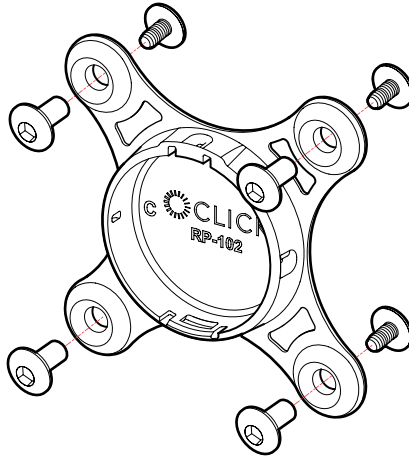

**Note:**

- If running laces in parallel, use lace ports **B** and **C**.
- If running laces opposite, use lace ports **A** and **C**.

### 2 Mount the lace guides:

- Drill 5mm holes into device at desired guide locations.
- Orient the guides.



- Arrange the top cap into the **Fixed** or **Releasing** position.

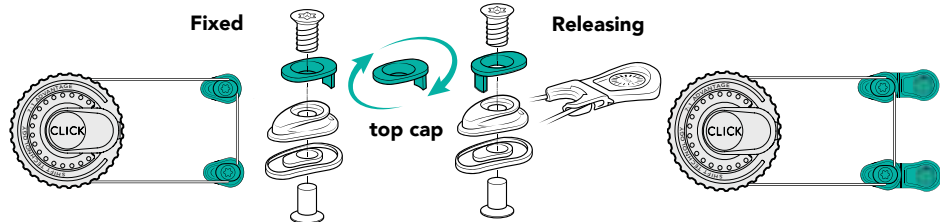

- Attach with included hardware or rivet (not included).

### 3 Lace the device.

Start at the collar and lace through guides.

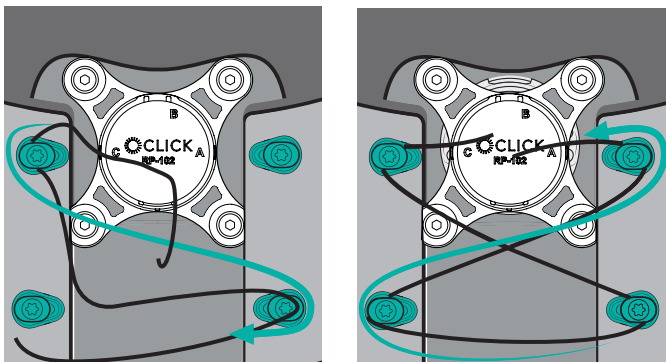

#### PROPER fixed guide lacing:



#### IMPROPER fixed guide lacing:

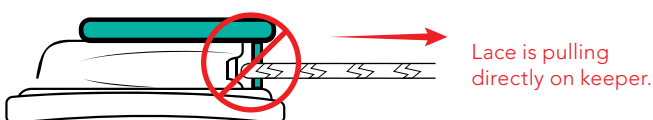

For releasing guides, simply wrap lace around guide until you install the releasing handle.

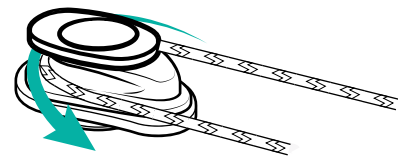

Add releasing handles to the lace (if configuring releasing guides).

Feed lace through **OR** Snap handle onto the lace

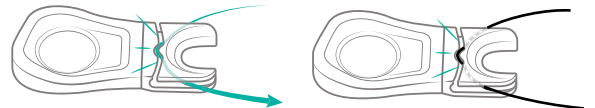

Then slide the handle onto each releasing guide base.

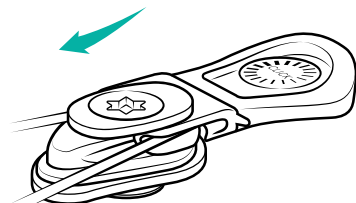

## 4 Attach lace to the Click Reel.

### Step 1

Ensure that the reel is ready for lacing. Both lock plugs should be in place. The **green marks** on the spool should align with the **green marks** on the washer. If necessary, turn dial to align **green marks**.

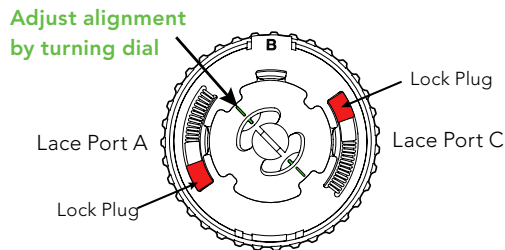

### Step 2

Lace the device. Attach each lace to its corresponding lace port on the reel - A, B, or C.

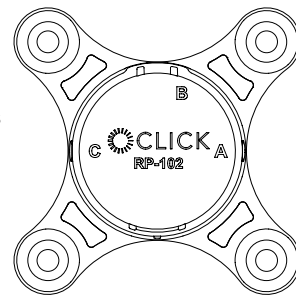

### Step 3

Lace the reel using the plastic lace feeder.

#### Pro Tip:

Gently pull the lace through the cavity to avoid breaking the plastic lace feeder

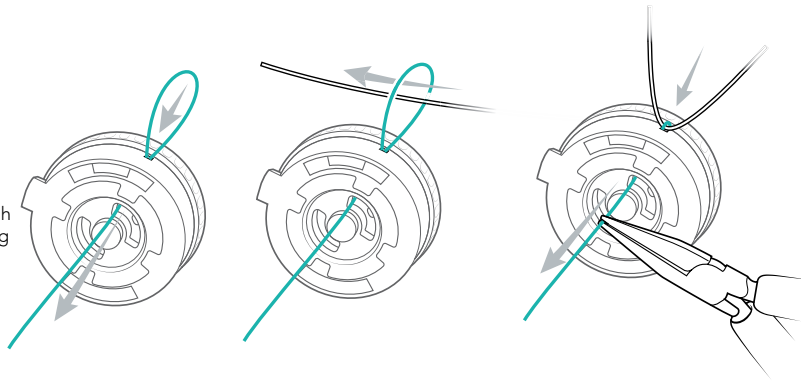

### Step 4

Tie a **double overhand** knot and trim tail to ~5mm and lightly burn the end of the tail.

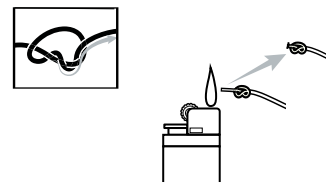

### Step 5

Pull lace to seat knot in the far lace pocket, on the opposite side of the **green marker**.

**Completely push knot into the cavity with a #1 flathead screwdriver:**

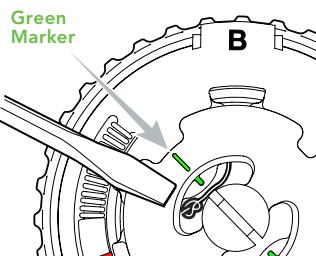

### Step 6

Pull open lace end to remove loose lace from device.

Repeat Step 3 to feed open lace end through reel.

Measure out ~10cm of lace.

Repeat Step 4 to tie double overhand knot, trim and seat it.

### Step 7

## Decide which reel mode to activate:

For more information on reel modes, watch our video here: <http://vimeo.com/7869809811>

ADJUSTABLE DESIGNS WITH  
**Less than 3" of lace uptake**

75% of Applications



Keep Red Lock Plugs installed in the reel

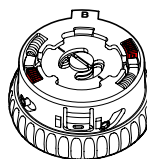

ADJUSTABLE DESIGNS WITH  
**More than 3" of lace uptake**

25% of Applications

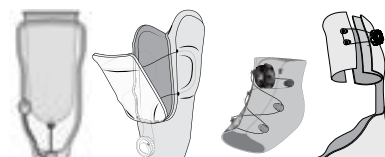

Remove Red Lock Plugs after lacing the reel.

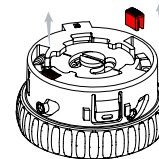

**Pro Tip:** CFABs should deliver device with Red Lock Plugs installed in reel. This will allow the practitioner to decide if they want Power Mode or Shift Mode.

## 5 Install the Click Reel:

1. Insert the foot of the reel into the void in the bottom of the collar opposite of the metal insert.

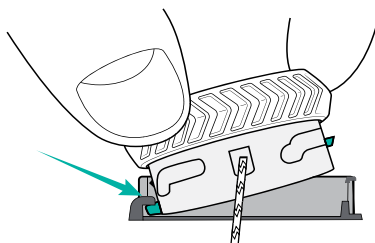

2. Press the reel firmly into the collar (you should hear a "CLICK" when secure).

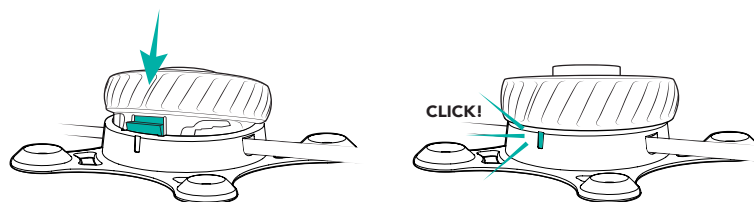

## 6 Test function.

Cycle the system 3 times before delivering to verify proper function.

## 7 Important.

As a final step of fabrication, attach the patient **Instructions For Use** hangtag on dial.

# How to use the Click Reel

- 1** Turn reel clockwise to quickly take up lace.



Fast Wind or Full Release  
Mode = Silent (Smooth)

- 2** Reel will automatically shift to high power mode as it tightens.



Power Mode =  
"Clicking" (Tactile)

- 3** Micro-adjust by turning forward or backward.



**Pro Tip:** If you prefer the reel to operate ONLY in Power Mode for constant micro-adjustment, replace the lock plug to "disable" the Shift function.

- 4** To fully release, unwind counterclockwise until "clicking" stops.



Teach your patients how to release and reconnect the releasing guides:

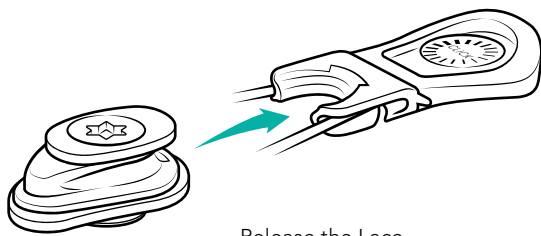

Release the Lace.

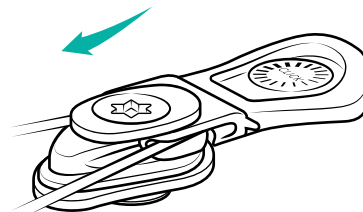

Reconnect the Lace.

## To remove the Click Reel:

- Locate the metal insert.
- Insert a small #1 flathead screwdriver between the metal insert and the reel body.
- Gently pry the reel upwards.

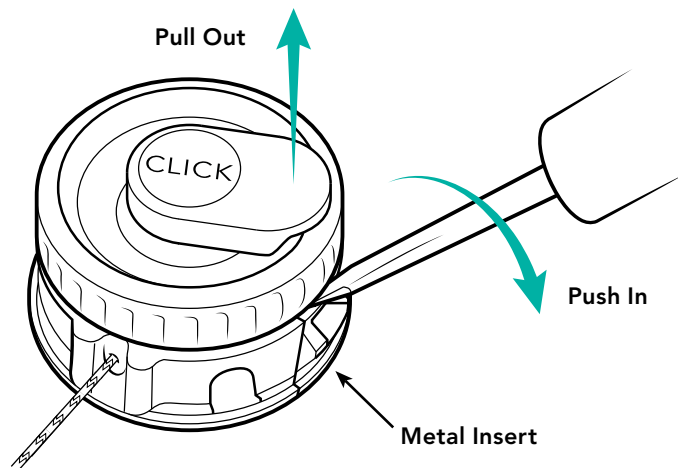

See [clickmedical.co/instructions](http://clickmedical.co/instructions) for detailed instructions for replacing/re-lacing a reel.

At delivery of device with patient present, scan *Instructions For Use* Hangtag. Please review with your patient how to use the Click Reel and to care for and maintain their RevoSurface system.

Regularly inspect your RevoSurface system.



### Inspect lace:

- ✓ Check for wear or damage routinely
- ✓ Replace at any sign of wear
- ✓ Replace lace every 6 months



This product is waterproof and submersible. Rinse with fresh water after use in saltwater, sand, or mud.

# Adding Adjustability to your 3D Printed Device

## 3D Print

Use these instructions if you are building a 3D printed device.

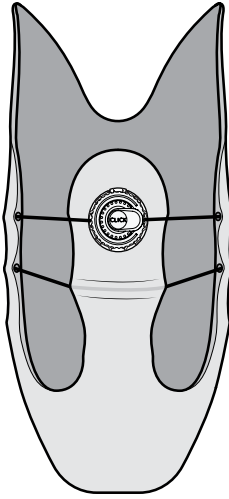

## Fabrication Overview:

1. Pick a Panel, Gap or Hinge design.
2. Locate areas of desired adjustment and placement of reel.
3. Download the reel mounting geometry from Click Academy and then integrate reel and lace paths into the CAD model, OR decide to apply all surface mounted components.
4. Print device.
5. Apply the RevoSurface components.
6. Test device for function.

For material suggestions and guidelines, please refer to the **Material Data Sheet**: [clickmedical.co/mds](http://clickmedical.co/mds)

## Determine Adjustable Design Type:

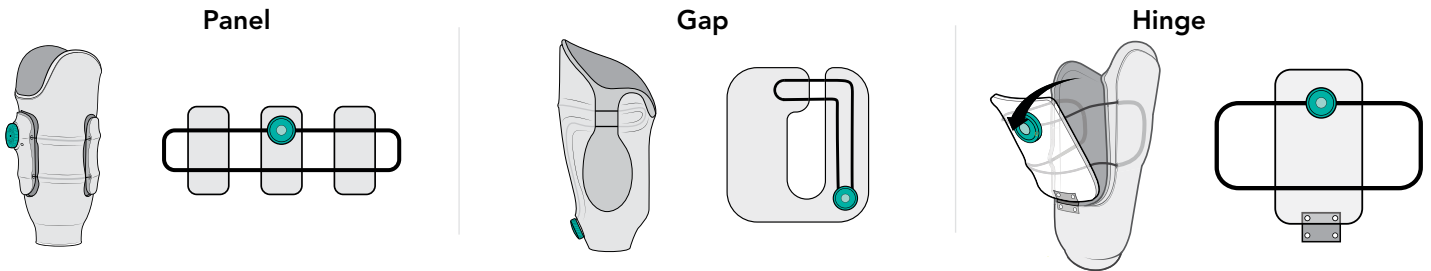

**Additional Designs:** To learn more about designing adjustable RevoSurface devices, enroll in [ClickAcademy.co](http://ClickAcademy.co)

## Draw lace routing onto socket:

### PANEL DESIGN RULE:

- $\frac{1}{4}$  rule = length of panel  $\div$  4. Tube must be  $\frac{1}{4}$  distance from top/bottom edges.
- Tubes must cross panel parallel to each other.
- Tube must cross panel at a perpendicular angle to edge.
- Tube must extend 1cm on the frame before turning.

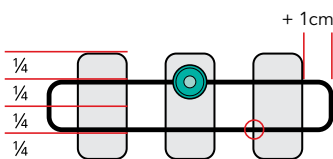

### GAP DESIGN RULE:

- Tubes must cross gap parallel with each other.
- Tube must cross gap at a perpendicular angle to edge.
- Tube must extend straight 1cm on the frame before turning.

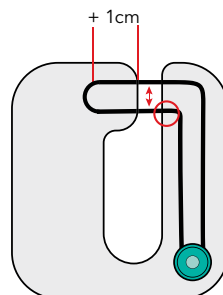

### HINGE DESIGN RULE:

- Use  $\frac{1}{4}$  rule to determine where to route closure points.
- Tube must extend 1cm on the frame before turning.
- Hinge must be at a different level (in the transverse plane) than closure points.

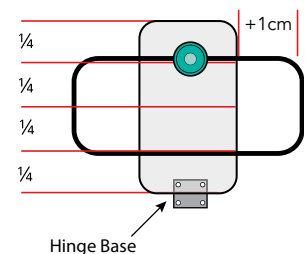

## Option 1 - Integrating the Reel & Lace Mounting Geometry:

- 1 Download the dummy file for the Reel mounting geometry. To access this file, please enroll or login to Click Academy. The file can be found in the RevoSurface Build It course.



- 2 Integrate the reel mounting geometry into the model of your device.

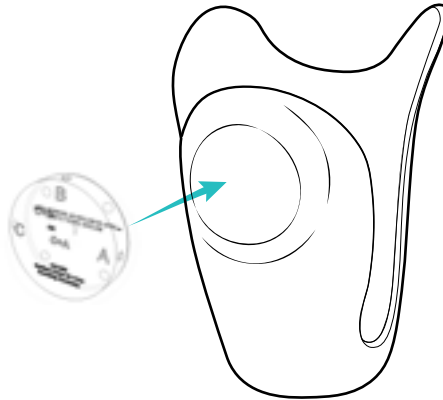

- 3 Rotate the geometry to align the lace exits with the lace path.

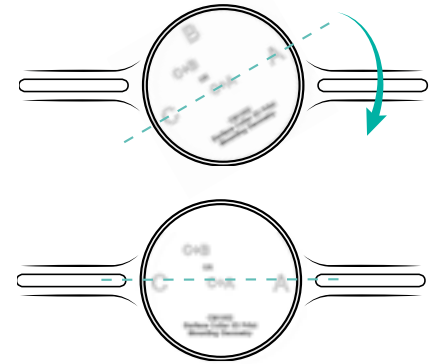

## Creating Integrated Lace Path Geometry:

### 4 Creating Lace Channels:

Why integrate the lace path?

Creating 3D printed lace paths have the advantage of streamlined integration and a lower profile. However, this technique is more complicated, so we suggest using this method only after you have gained experience creating and printing adjustable designs.

#### Step 1

Create tubing channels with an inner diameter of 3.2mm so that the tubing can be inserted into the device.

The tubing is required as it protects the lace and significantly reduces lace friction.

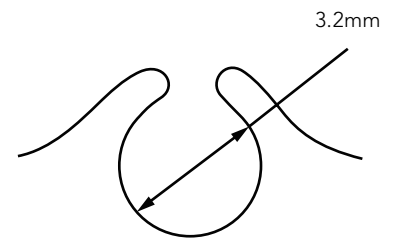

#### Step 2

Create open lace paths along the device to allow for printing medium to be cleaned out of lace paths.

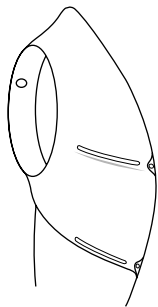

#### Step 3

At the end of each open lace path, close off the entire 360-degree path for ~5mm to fully capture the tube.

This prevents deformation of the tubing during device use.

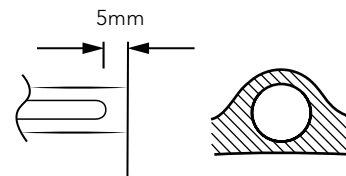

#### Step 4

If you enclose the lace path in the middle of the lace path for printing support or durability, keep the enclosed areas relatively short, less than 3cm.

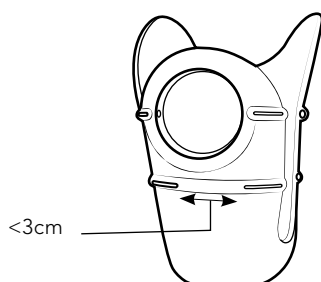

#### Step 5

Ensure that lace tracks will be well aligned once the device is tightened. This will greatly increase lace life in the device.

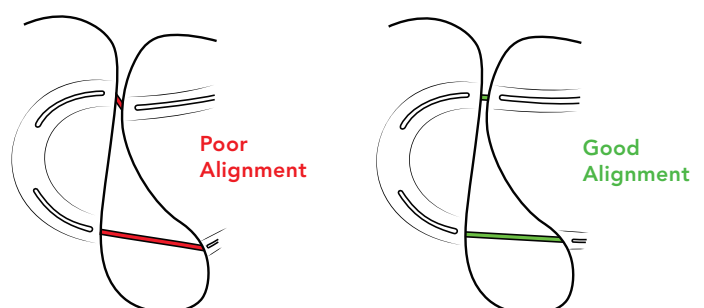

## Installing Components into Integrated Geometry:

### 5 Trim the Surface Collar:

Clip all four arms off of the collar, keeping the cuts close to the outer diameter of the collar.

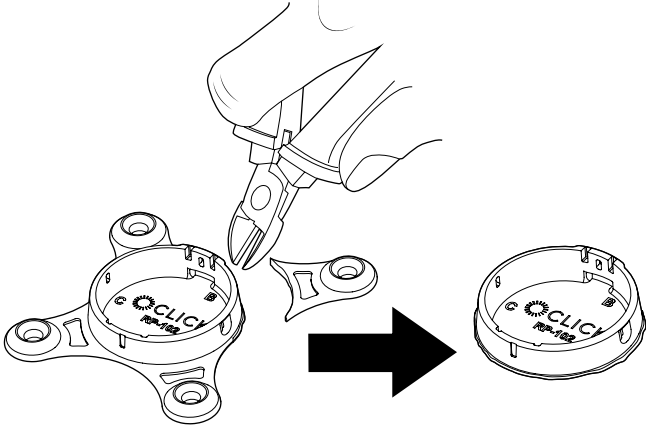

### 6 Test Fit the Collar into the Reel Cavity:

If the collar does not fit into the cavity, sand the edges of the collar to allow the collar to sit flat on the cavity floor.

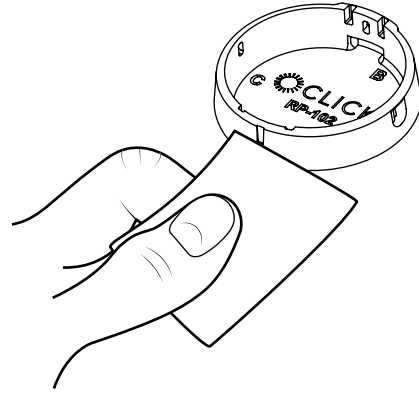

### 7 Rough up the Back Surface of the Collar:

Take sandpaper to the back flat surface of the collar and rough up the surface to improve adhesion.

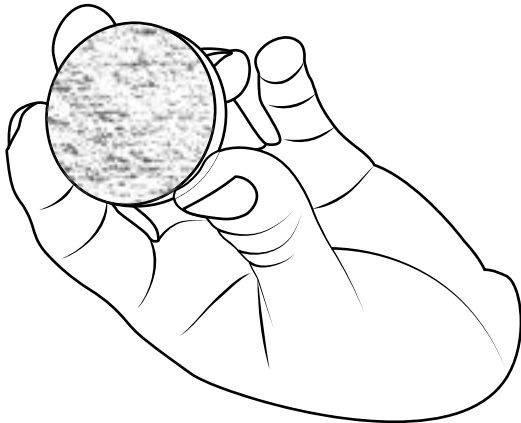

### 8 Apply 60 Second Adhesive:

Cover at least 50% of the roughed up back surface of the collar with 60 second adhesive.

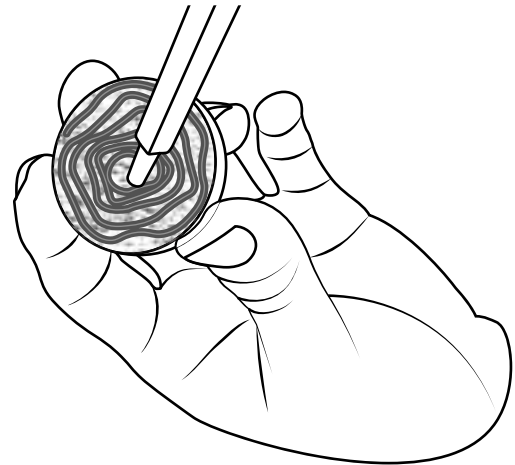

### 9 Place Collar in Device:

With the adhesive side down, place the collar in the reel cavity of the device, pressing the collar down firmly. Rotate the collar as necessary to align the lace ports of the collar with the correct ports in the device.

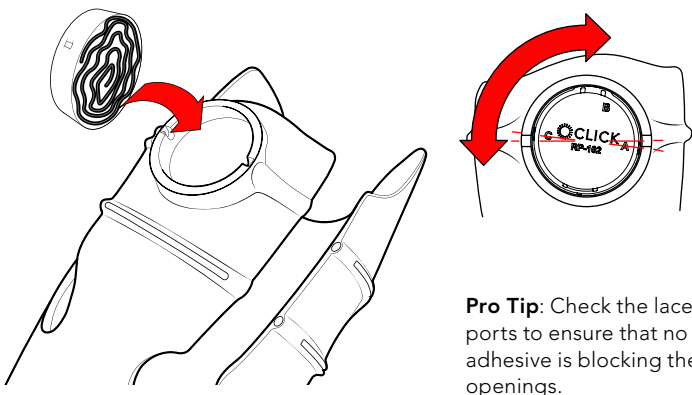

### 10 Insert Tubing in Lace Channels & Lace Device:

Insert tubing into each lace channel until tubing exits the end of the channel by 3-5mm. Trim tubing at both ends with a sharp blade for a clean, flush surface. Pull lace through tubing with the loose ends remaining in the collar. (Go to pg 18)

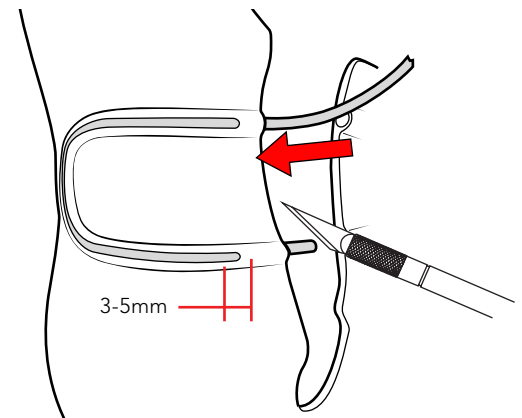

## Option 2 - Using Surface Mounted Components:

### 1 Mount the Surface Collar:

- Determine ideal placement.
- Grind a small flat area if the device has a small circumference.
- Mark and drill one of the holes, using a 3mm drill bit.
- Attach one arm of collar with a Chicago Screw.
- Mark other holes, rotate collar out of the way, drill holes and attach Chicago Screws.

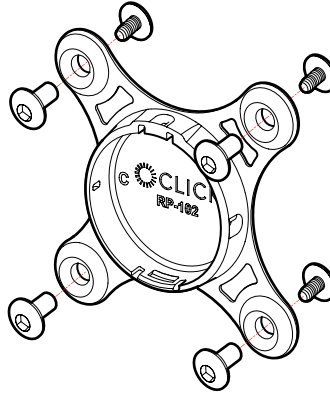

**Note:**

- If running laces in parallel, use lace ports **B** and **C**.
- If running laces opposite, use lace ports **A** and **C**.

### 2 Placing and Installing Surface Guides:

Why use Surface Guides?

- They are easy to place after printing.
- They can simplify the 3D design process.
- They allow for lace path optimization after printing.

#### Step 1

After printing, identify the lace path and surface guide locations by using these guidelines:

Pair Lace Guides to create lace paths.

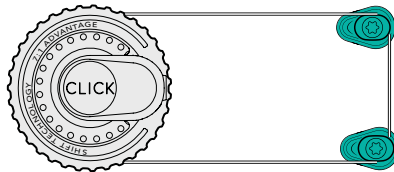

Paired Guides span larger distances.

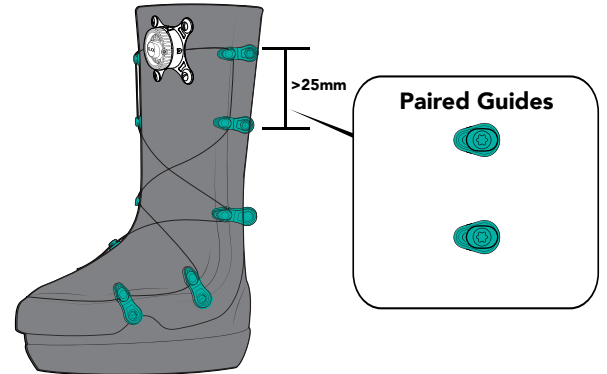

#### Step 2

Mark the location of each Surface Guide screw hole on the device.

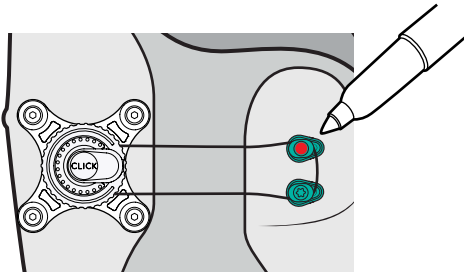

#### Step 3

Drill 3mm holes to accept the Surface Guides.

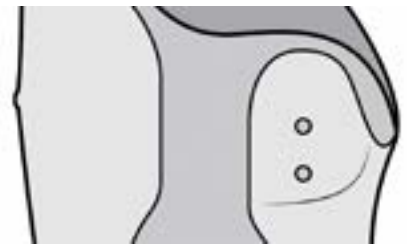

### 3 Mount the Lace Guides:

- Drill 5mm holes into device at desired guide locations.
- Orient the guides.

Orient the pointed end towards the **direction of the force**.



- Arrange the top cap into the **Fixed** or **Releasing** position.

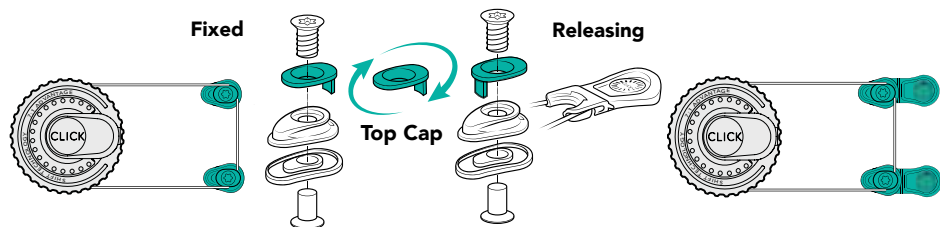

- Attach with included hardware or rivet (not included).

## Lace the Device:

### 4 Lace the Device.

Start at the collar and lace through guides.

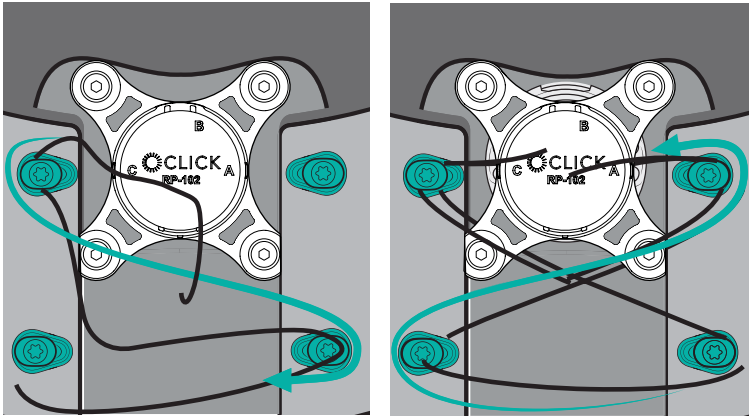

#### PROPER fixed guide lacing:

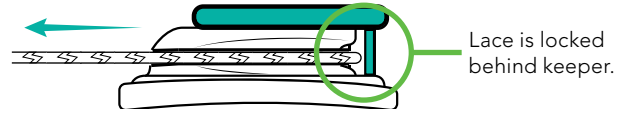

Lace is locked behind keeper.

#### IMPROPER fixed guide lacing:

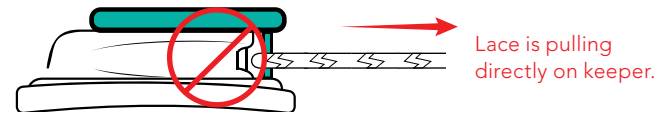

Lace is pulling directly on keeper.

For releasing guides, simply wrap lace around guide until you install the releasing handle.

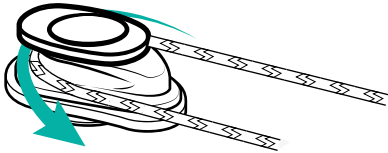

Add releasing handles to the lace (if configuring releasing guides).

Feed lace through **OR** Snap handle onto the lace



Then slide the handle onto each releasing guide base.

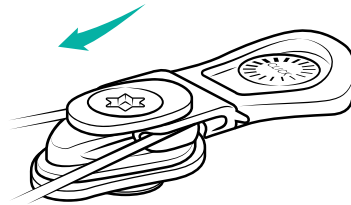

## Attach lace to the Click Reel:

### 1

Ensure that the reel is ready for lacing. Both lock plugs should be in place. The green marks on the spool should align with the green marks on the washer. If necessary, turn dial to align green marks.

Adjust alignment by turning dial

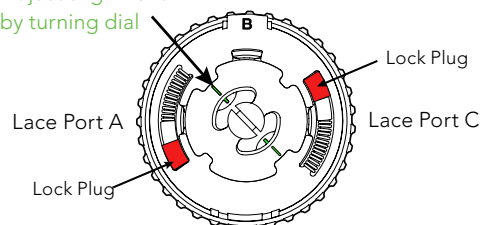

### 2

Lace the device. Attach each lace to its corresponding lace port on the reel - A, B, or C.

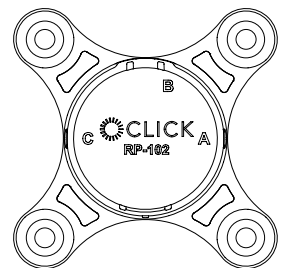

## Attach lace to the Click Reel (Continued):

3

Lace the reel using the plastic lace feeder.

**Pro Tip:**

Gently pull the lace through the cavity to avoid breaking the plastic lace feeder.

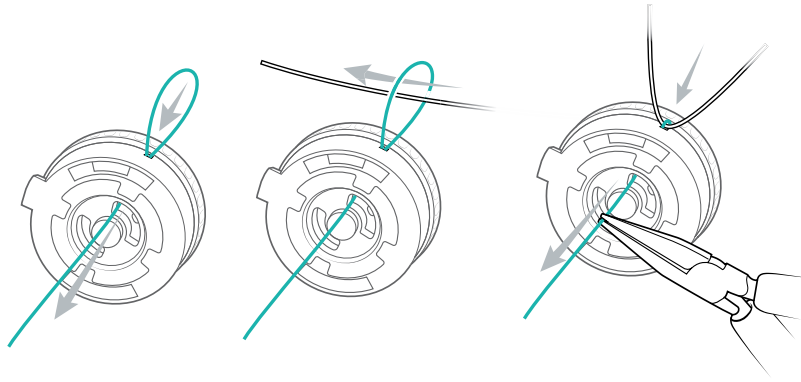

4

Tie a **double overhand** knot and trim tail to ~5mm and lightly burn the end of the tail.

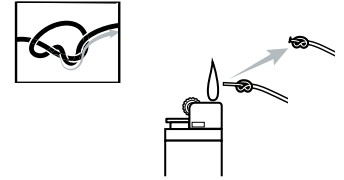

5

Pull lace to seat knot in the far lace pocket, on the opposite side of the **green marker**.

**Completely push knot into the cavity with a #1 flathead screwdriver:**

6

Pull open lace end to remove loose lace from device.

Repeat Step 3 to feed open lace end through reel.

Measure out ~10cm of lace.

Repeat Step 4 to tie double overhand knot, trim and seat it.

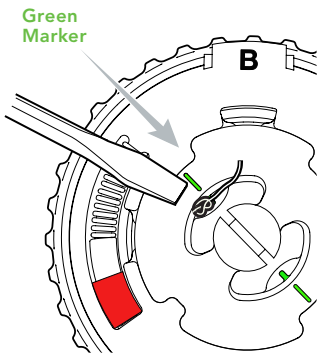

7

### Decide which reel mode to activate:

For more information on reel modes, watch our video here: <http://vimeo.com/7869809811>

ADJUSTABLE DESIGNS WITH **Less than 3" of lace uptake**

75% of Applications



Keep Red Lock Plugs installed in the reel

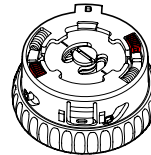

ADJUSTABLE DESIGNS WITH **More than 3" of lace uptake**

25% of Applications

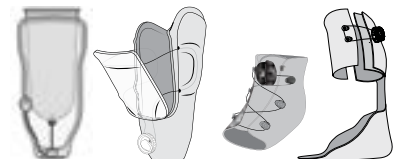

Remove Red Lock Plugs after lacing the reel.

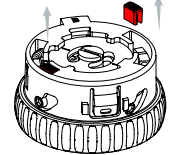

**Pro Tip:** CFABs should deliver device with Red Lock Plugs installed in reel. This will allow the practitioner to decide if they want Power Mode or Shift Mode.

## 8 Install the Click Reel:

1. Insert the foot of the reel into the void in the bottom of the collar opposite of the metal insert.

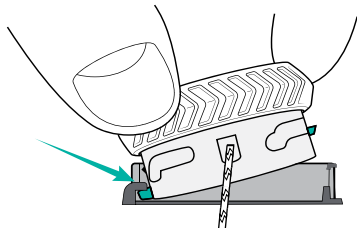

2. Press the reel firmly into the collar (you should hear a "CLICK" when secure).

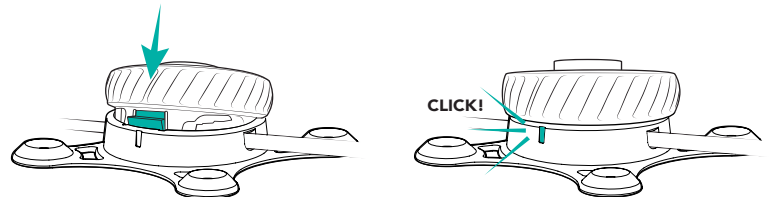

## 9 Test Function.

Cycle the system 3 times before delivering to verify proper function.

## 10 Important.

As a final step of fabrication, attach the patient **Instructions For Use** hangtag on dial.

# How to use the Click Reel

- 1 Turn reel clockwise to quickly take up lace.



Fast Wind or Full Release  
Mode = Silent (Smooth)

- 2 Reel will automatically shift to high power mode as it tightens.



Power Mode =  
"Clicking" (Tactile)

- 3 Micro-adjust by turning forward or backward.



**Pro Tip:** If you prefer the reel to operate ONLY in Power Mode for constant micro-adjustment, replace the lock plug to "disable" the Shift function.

- 4 To fully release, unwind counterclockwise until "clicking" stops.



Teach your patients how to release and reconnect the releasing guides:

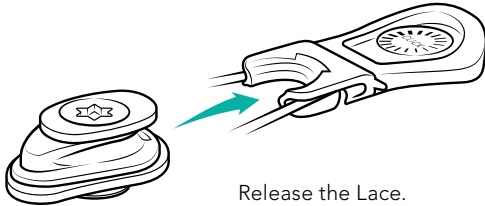

Release the Lace.

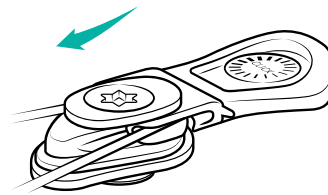

Reconnect the Lace.

## To remove the Click Reel:

- Locate the metal insert.
- Insert a small #1 flathead screwdriver between the metal insert and the reel body.
- Gently pry the reel upwards.

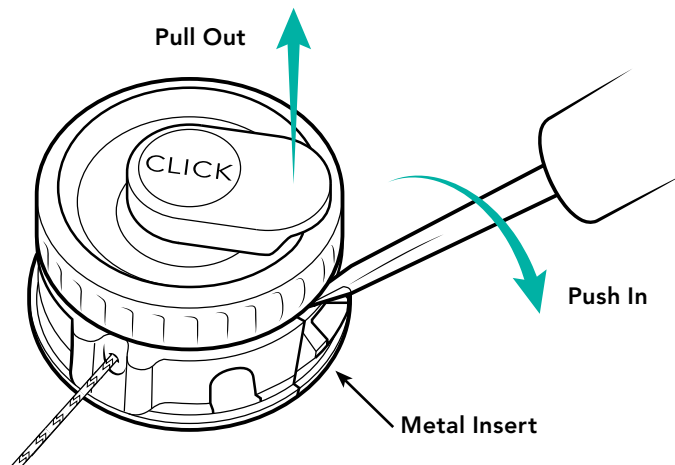

See [clickmedical.co/instructions](https://clickmedical.co/instructions) for detailed instructions for replacing/re-lacing a reel.

At delivery of device with patient present, scan *Instructions For Use Hangtag*. Please review with your patient how to use the Click Reel and to care for and maintain their RevoSurface system.

Regularly inspect your RevoSurface system.



### Inspect lace:

- ✓ Check for wear or damage routinely
- ✓ Replace at any sign of wear
- ✓ Replace lace every 6 months



This product is waterproof and submersible. Rinse with fresh water after use in saltwater, sand, or mud.

**UK REP**

MDSS-UK RP LIMITED, 6 Wilmslow Road  
Rusholme, M14 5TP Manchester  
United Kingdom

**CH REP**

MDSS CH GmbH, Laurenzenvorstadt 61  
5000 Aarau, Switzerland

**MD**

MDSS GmbH, Schiffgraben 41  
30175 Hannover, Germany

**EC REP**



Click Medical, LLC, 1205 Hilltop Parkway, W101  
Steamboat Springs, CO 80487, USA +1-970-670-7012