

2025

CLICK[®]
MEDICAL

A black and white photograph of a man with a prosthetic left leg running on a dirt path. He is wearing a long-sleeved shirt, shorts, and a headband. A dog is running alongside him. The background consists of trees and a path leading into the distance. The overall tone is positive and active.

The Guide to Adjustability



Let's Improve Lives





Born on the ski slopes.

WHO WE ARE

It all started in 2009, when Certified Prosthetist Joe Mahon was on the ski slopes of Utah. He got a call from a patient who needed him to adjust her device.

He then noticed snowboarders adjusting their boots quickly and easily with the turn of a dial. A light bulb went off. What if that same system could be used to create adjustability in a prosthetic device?

With that idea, RevoFit® was born, creating the first adjustable-socket technology that allows patients to control the fit of their device with a simple turn of a dial.

The rest is history.



WHAT WE DO

Adjustability for *everyone*

Every day we adjust hundreds of things — belts, mirrors, shoes, office chairs, beds, car seats. The list goes on and on. Adjustability isn't a "nice to have." We expect it.

So why do patients still have rigid orthotic and prosthetic devices? They put devices on their bodies every day that, to fit and be comfortable, require a complicated system of socks. Or, need you, their provider, to refit their device again, and again, and again.

Click Medical makes the only adjustable solution for custom O&P devices. You can put adjustability in your patient's hands. **They'll have the power to micro-adjust their fit with the turn of a dial.**



Patient Kim "Tin Man" Acheson, with Hanger Clinic Provider Leah Bowman, in Eau Claire, WI

WHY WE DO IT

Why Click Medical[®] Adjustable Solutions?



Positive Outcomes

75% agreed that RevoFit adjustability improved the health of their patient.

Click Medical Beta Test 2023

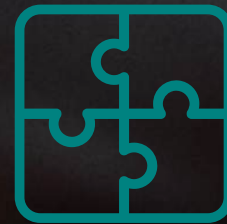

Fit Matters

Adjustability gives you the power to design a device that allows your patients to adjust their fit with the turn of a dial.

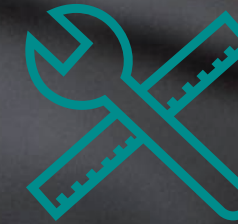

Fewer Re-Fits & Re-Makes

When patients can adjust their fit, you will spend less time re-fitting or remaking devices.



Endless Design Options

Be the hero by solving for a wide variety of patient fit issues with unlimited design options.

Click[®] Reel

offers reliable, repeatable and predictable adjustability



Powerful

Shifts for speed and strength. Fast lace uptake (1:1) automatically shifts to power mode (7:1) for increased power and precise adjustment.

Use for patients up to 300lbs/135kg.

Bi-Directional

Micro-adjustable when tightening and releasing tension.

Durable

Metal components ensure safety and long life.

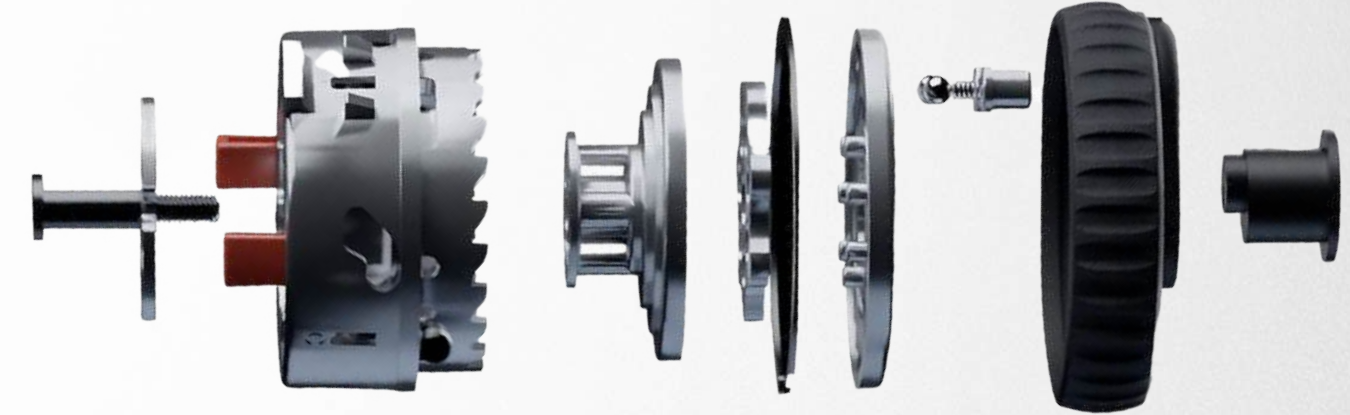

Low Profile

The reel's 24mm streamlined profile seamlessly integrates into devices.



Guaranteed For Life

The Click Reel is guaranteed for the life of your patient's device.

The Click® Reel can work in 2 different modes,
Power & Shift Mode

Power Mode: Micro Adjustable

ADJUSTABLE DESIGNS WITH **Less than 3"** of lace uptake

USE RED LOCK PLUGS

75% of Applications

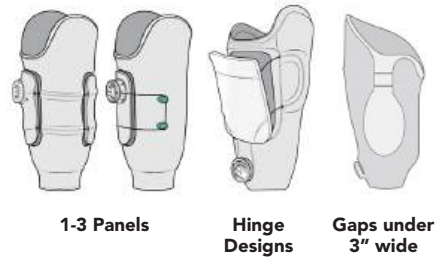

1-3 Panels Hinge Designs Gaps under 3" wide



MICRO

Turn left to loosen Turn right to tighten



7:1
Mechanical Advantage

Clicking

Shift Mode: Macro & Micro Adjustable

ADJUSTABLE DESIGNS WITH **More than 3"** of lace uptake

NO RED LOCK PLUGS

25% of Applications

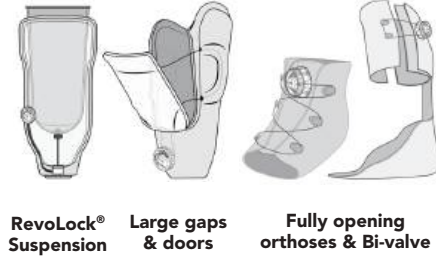

RevoLock® Suspension Large gaps & doors Fully opening orthoses & Bi-valve



MACRO

Turn right for fast lace uptake

1:1
Fast Lace Uptake & Release

— Silent —

As lace tension increases, the reel automatically shifts into MICRO functionality

SHIFT ZONE

RELEASING

Once lace becomes slack, the reel automatically releases the lace

MICRO

Turn left to loosen Turn right to tighten

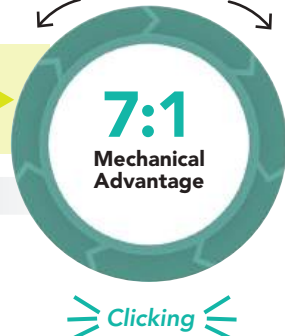

7:1
Mechanical Advantage

Clicking

Did you know?

Click Medical conducted a 13 month clinical study that engaged:



21 Practices



29 Practitioners



32 Technicians



55 Amputees

This study measured patient impressions monthly to assess amputee's perceived value of an adjustable socket vs. a static socket, socket fit, socket comfort, and impact to their mobility.

OUTCOMES

Test Subjects

- 100%** Agreed that they **preferred an adjustable** socket to a static socket.
- 100%** Agreed that micro adjustability provides a **better all day fit**.
- 97%** Agreed that their adjustable socket was **more comfortable** than a static socket.
- 92%** Agreed that their **mobility increased** when using an adjustable socket.

Practitioners

- 88%** Agreed that having RevoFit adjustability **increased their patient's mobility**.
- 75%** Agreed that RevoFit adjustability **improved the health of their patient**.

Add adjustability onto a device in an instant



Amy Cutler, Laboratory Manager from Agile Orthopedics applying RevoSurface to a device in Denver, CO

RevoSurface Solves For:

- ✓ The unknowns when verifying design and functionality on check sockets
- ✓ Donning/doffing difficulties
- ✓ Poor-fitting existing devices, especially due to volume changes
- ✓ Lack of flexion and extension control on hinged devices
- ✓ Troublesome Velcro® on cuffs, AFOs, sockets, and shoes

“ RevoSurface gives us options for providing reliable adjustability for our new and long-term patients, allowing them to experience the benefits of adjustability without the additional cost of a laminated socket. ”

- Chet Dixon, Teh Lin Prosthetics & Orthotics

Let your creativity drive solutions.



Try it

Introduce your patient to adjustability with RevoSurface.

Prove it

Experiment and modify devices without refabrication.

Reuse it

The RevoSurface Tool Kit parts are easy to remove and reuse.

Integrate adjustability in any device



David Dennis, RevoFit user since 2019

Do what you do even better.

Endless design options let you solve for each client's unique fit challenges, and improve their overall health and wellbeing.

Save time and money.

With RevoFit, you'll spend less time and money on remakes and refits. Go ahead and take Saturday off!

Drive positive outcomes.

RevoFit adjustability lets patients control their fit and comfort which leads to regular use of their devices, increased activity, and better health.



RevoFit Kits are best for patients with:

- ✓ Significant volume changes
- ✓ Rotation issues
- ✓ Weight and activity changes
- ✓ Distal tibia/femur pressure
- ✓ Limb levering in socket
- ✓ Skin breakdown issues
- ✓ Bulbous distal ends

For detailed videos, tips and tricks enroll in [CLICKACADEMY.co](https://clickacademy.co)

Certified Prosthetists' Preferred Adjustable Solution



“ RevoFit truly helps us provide the ultimate functional devices to patients! ”

- Westcoast Brace & Limb

“By adding Click Medical solutions to our proven socket designs, we created a superior adjustable device — a win-win for patients and for our practice.”

Scott Sabolich, CP, LP
President Ottobock Patient Care – North America



CMS Grants Click Medical Approval for *Two* Coveted L-Codes: L5783 and L7406



Click Medical proudly announces the approval of two critical HCPCS codes by CMS, expanding coverage and reimbursement for its innovative RevoFit technology to all prosthetics.

L5783 (Effective April 1, 2024):

This code applies to custom adjustable lower-extremity sockets with RevoFit, enabling users to manually adjust socket volume throughout the day for enhanced comfort and fit. Reimbursement for L5783 is set at \$3,015.92 for 2024, with RevoFit serving as the predicate product.

Details are available on CMS.gov - reference LCD L33787 and policy article 52496 for Lower Limb Prosthetics.

L7406 (Effective April 1, 2025):

Newly approved, this code extends RevoFit's benefits to upper-extremity prosthetics. Reimbursement for L7406 is set at \$3,088.30.

With these approvals, RevoFit adjustability is now covered for both upper and lower extremity prosthetics, offering comprehensive support for individuals with limb loss or limb difference.

For complete coding information, visit:
clickmedical.co/revofit/#insurance-coding

“Finally, O&P professionals can be reimbursed for delivering adjustable sockets to deserving patients. We are grateful for CMS' decision to award these two new codes, and hope it inspires other innovators.”

Brian Simmons, Click Medical
VP Business Development

RevoLock® Align Kit and 4-Hole Kit with the Click® Reel, and RevoLock® Lanyard V3 with BOA® Dial

Safe, reliable limb alignment & suspension

RevoLock Kits are best for patients with:

- ✓ Long limbs
- ✓ Bulbous distal ends
- ✓ Balance issues
- ✓ Strength issues
- ✓ Large and frequent volume changes
- ✓ Insufficient suspension systems

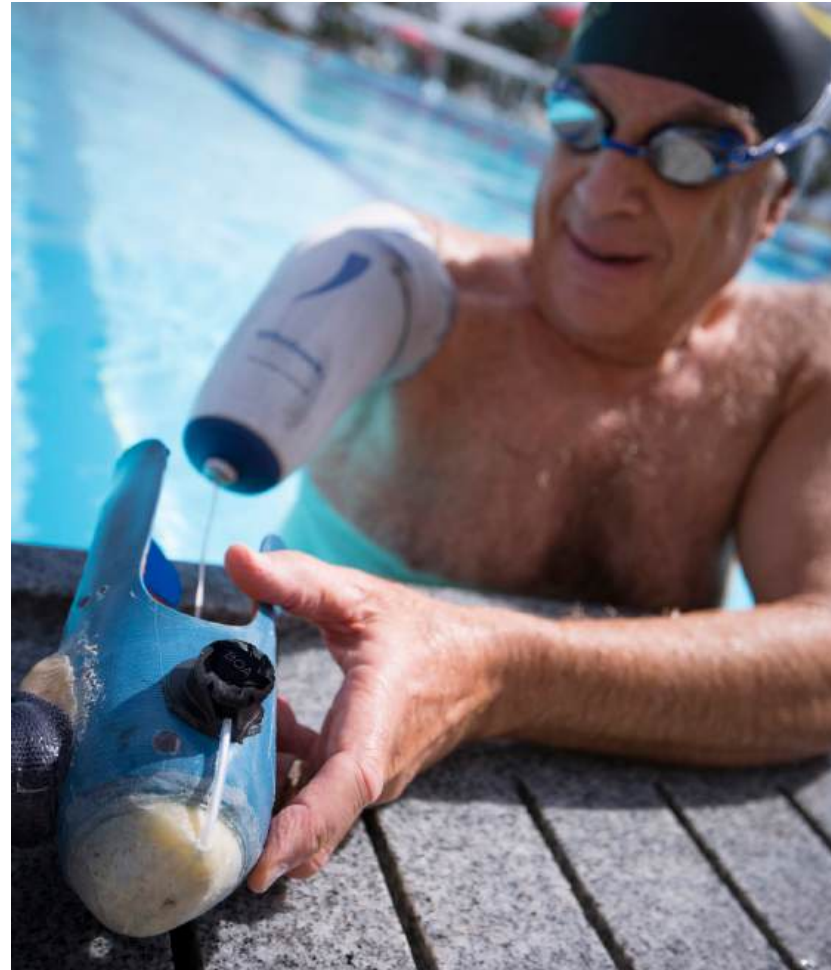

Peter Mueller, RevoLock user since 2016



RevoLock Lineup

	RevoLock Lanyard V3 with BOA Dial (Replacement of RevoLock Lanyard V2)	RevoLock 4-Hole with Click Reel	RevoLock Align with Click Reel
Key Components	RL-302-22-01	RL-300-07-01	RL-301-07-01
Reel	 BOA Lanyard V2 & V3 Dial	 Click Reel	 Click Reel
Lamination Collar	 Lamination Collar	 Lamination Collar + Slider	 Lamination Collar + Slider
Distal Housing	 V3 Distal Housing	 4-Hole Housing	 Align Housing
Liner Attachment	 LE Quick Connect Insert + Snap	 LE Quick Connect Insert + Snap	 LE Quick Connect Insert + Snap
Lace	 HC Lace	 HC Lace	 HC Lace
Tubing	 Lamination Tubing	 Lamination Tubing	 Lamination Tubing

Easy

- The Click Reel quickly and easily pulls the limb into position
- Micro-adjustable when volume or activity levels change
- Quick Connect Snap makes it easy to attach to the liner

Safe

- Don or doff while seated, reducing the chance of falls
- Adjustable suspension reduces pistoning and skin shear
- Decreased distal tension while sitting allows for fluid recovery and volume stabilization

Secure

- Secure suspension regardless of limb position
- Quick Connect Snap locks onto the liner and prevents unintentional detaching
- New slider feature locks limb in the socket but still allows for micro-adjustability

Overcome the challenges of suction & pin lock suspension.

For more information on RevoLock parts, see page 40.

“

Being able to turn the dial until the user feels seated in the socket gives them a sense of security when they stand and ambulate.

— **Regan Thompson, CPO**
at RISE in Denver, CO



Which RevoLock Kit should I choose for my patient?

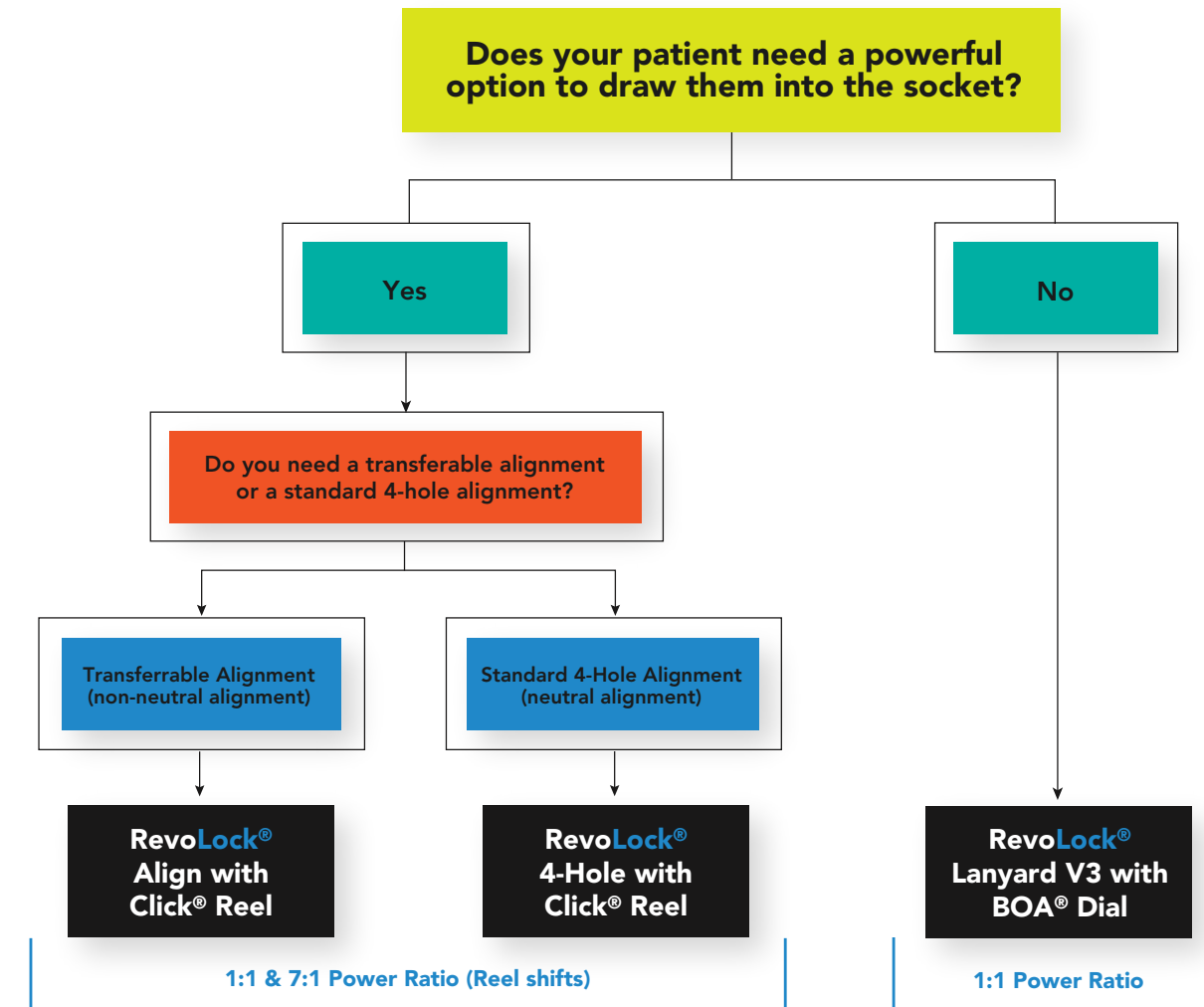

Which RevoLock Replacement Kit Should I Choose?

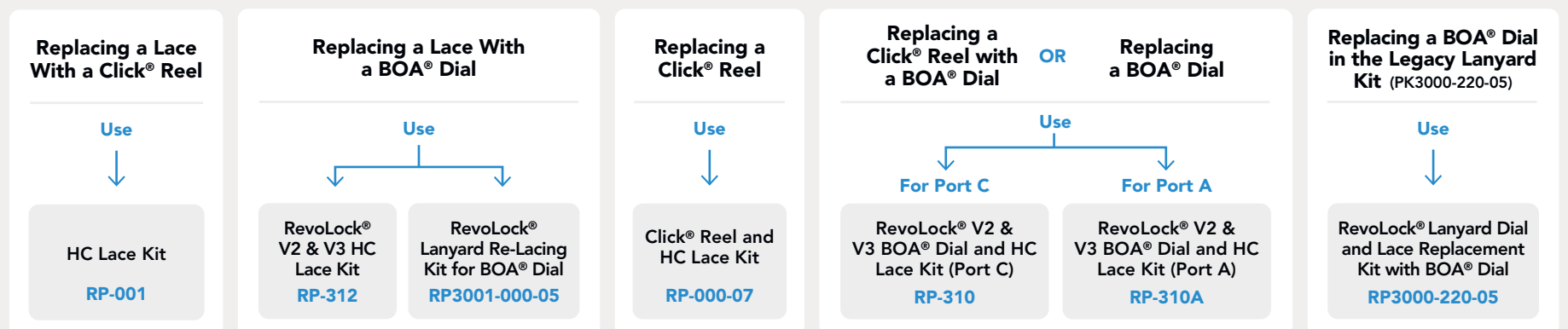

QuickFit® Lacer with the low-power BOA® Dial

A preassembled system that easily rivets onto any shoe, cuff, or AFO.

QuickFit Lacers are best for patients with:

- ✓ Diabetes
- ✓ Reduced dexterity
- ✓ Compromised hand strength
- ✓ Balance issues



1 Add Onto New or Existing Orthoses

Either use the kit for fabrication of new cuffs and AFO's, or easily upgrade a pair of shoes.

3 One-Handed, Micro-Adjustment

Patients can easily adjust their device, quickly adapting to changes in activity or support needs.

2 Easy Rivet-on Installation

Using the QuickFit Rivets and QuickFit Tool allows installation in under 5 minutes.

QuickFit Lacers are available in four sizes as well as a releasable version. See page 41 for details.

QuickFit® Straps & Buckles with the low-power BOA® Dial

QuickFit® Strap 1.5" (OK1410-130-05)

QuickFit Straps quickly install on a wide variety of cuffs, orthoses, and prosthetic devices, making adjustments easy and more effective.



Micro-Adjustable

Each "click" of the low power BOA dial moves the strap 1mm for the perfect fit every time.

Fast, Easy and Customizable

The cut-to-size QuickFit Straps are prefabricated, durable, and installs in minutes.

User-Friendly

Adjustability allows for a true and comfortable fit, resulting in increased use of devices.



QuickFit® Buckle 1.5" (OK1415-000-05)

We recommend adding the QuickFit Buckle onto the QuickFit Strap for an easy, secure strap that never wears out.



Magnetic Self-Locating Buckle

Allows the user to easily connect the strap. It's perfect for patients with limited dexterity or for placement in hard-to-reach areas.

Easy One-Handed Use

Never Wears Out

The durable plastic interface eliminates the need to repeatedly hook and unhook Velcro®.



QuickFit Straps & Buckles are best for patients with:

- ✓ Hemiplegia
- ✓ Frequent volume and activity changes
- ✓ Compromised dexterity or strength issues
- ✓ Donning and doffing difficulties

CLICK**ACADEMY**

Learning how to adjust starts *here.*

Curious how to lace the Click® Reel?

Wonder if the RevoSurface® Tool Kit can help you quickly solve a current fit challenge?

Want to learn how to overcome the challenges of pinlock with RevoLock® Lanyard V3?

Look no further. Answers to your questions are in **CLICKACADEMY.**

There are four courses for each product:

1

Learn It.

Meet the product, and see different design opportunities and clinical applications.

2

Build It.

Chock full of videos, this course walks you through everything you need to know to add or fabricate our systems into your devices.

3

Optimize It.

It's all about fine-tuning! You'll find various great resources, from optimizing fit to replacing parts.

4

Expand It.

Discover endless design ideas. Submit your own design and add it to our growing Solution Series library!

Click Academy is certified in the
United States and Canada



ENROLL NOW



www.clickacademy.co

**24+ FREE
CEUs Available!**

“The RevoFit® system has enabled Sydney to manage volume changes throughout the day while maintaining secure seal-in suction suspension.

— Scott Moore, CP
Bulow Orthotics & Prosthetic Solutions,
Murfreesboro, TN



Positive *Outcomes*

Sydney Mashburn
RevoFit user since 2021





Click Medical[®] Product Catalog

Click Medical products are patent protected. For full list see www.clickmedical.co/patents

RevoSurface[®]





RevoFit[®]

RevoLock[®]







QuickFit[®]

Replacement Parts

RevoSurface®

SKU	Product	Description	Picture
RS-100-07-01	RevoSurface® Tool Kit with Click® Reel	<p>"This single RevoSurface Tool Kit with the Click Reel allows you to test adjustable designs and fit of check sockets, 3D printed devices, and on orthoses. It can also be used to solve fit issues on existing rigid devices.</p> <p>The Click Reel innovation creates adjustable devices with a lower streamlined profile, micro/macro adjustment that incrementally tightens and loosens with increased durability.</p> <p>Kit includes: 1x Click Reel, 2x Surface Collar, 2m HC Lace, 1.8m Lamination Tubing, 1x Metal Lace Feeder, 3x Plastic Lace Feeders, 1x Reel Tool, 6x Surface Guides, 3x Releasing Guides, 4x Chicago Screw assemblies</p> <p>User Weight Limit: 300lb (135kg)"</p>	
RP-001	HC Lace Kit	<p>2m of HC (High Capacity) Lace and Click Reel components for RevoSurface Tool Kit, RevoLock Align, and RevoLock 4-Hole Kits with the Click Reel.</p>	
RP-000-07	Click® Reel and HC Lace Kit	<p>Replacement Click Reel and 2m of HC (High Capacity) Lace for RevoLock Align, RevoLock 4-Hole and RevoSurface Tool Kits only.</p> <p>This is not for replacing a BOA® dial. Please see RP0100-320-05 for replacing a BOA® dial.</p>	
RP-101	Surface Guide 6-Pack	<p>The 6-Pack of Surface Guides allows a practice to have on hand additional guides for easy replacement and configuration changes. For RevoSurface Tool Kits with Click Reel only.</p>	

RevoSurface®

SKU	Product	Description	Picture
RP-102	Surface Collar	<p>2x Click Reel mounting collar. For surface mount only. Not for use with lamination.</p>	
RP-105	Surface Releasing Tab 3-Pack	<p>3-Pack Surface Releasing Tabs for converting a device from a fixed lace path to a releasing lace path to fully open the device or to replace existing Surface Releasing Tabs.</p>	
RP-201	Lamination Tube - 1.8m	<p>Replacement Lamination Tube (1.8m) for all Revo Kits with the Click Reel and BOA® dials.</p>	
BL-001	HC Lace - 25m Spool	<p>25m spool of HC (High Capacity) Lace assures you will always have replacement lace on hand.</p> <p>Cost effective, sustainable and less waste.</p> <p>Used in the RevoSurface, RevoLock Align, RevoLock 4-Hole, and RevoLock Lanyard V2 & V3 with BOA Dial.</p>	
AC-100-05	Comfort Grip Ring - Black 5-Pack	<p>Provide a soft-touch feel and 10% increased turning power to the existing Click Reel.</p> <p>Great for patients with dexterity issues.</p>	
AC-101-05	Power Grip Ring - Black 5-Pack	<p>Provide a soft-touch feel and 20% increased turning power to the existing Click Reel.</p> <p>Great for patients with dexterity and hand strength issues.</p>	
AC-000-00	Click® Care Kit	<p>The Click Care Kit enables you to service your clients in the office or on the road with everything readily accessible for maintaining, repairing or replacing Click components.</p> <p>Contents: 1x Surface Collar Kit, 2x HD Lace Kits, 2x HC Lace Kits, Flathead Screwdriver, Dental Pick, Spectra Scissors, Needle Nose Pliers & Reel Lubricant. Extra space is allocated for a Click® Reels and a lighter, which can be purchased separately.</p>	

RevoFit®

SKU	Product	Description	Picture
RF-200-07-01	RevoFit® Lamination Kit with Click® Reel	<p>This single RevoFit® Lamination Kit with the Click® Reel allows you to fabricate user-controlled adjustability anywhere on a device.</p> <p>The Click® Reel innovation creates adjustable devices with a lower streamlined profile, micro/macro adjustment that incrementally tightens and loosens with increased durability.</p> <p>Kit includes: 1x Click Reel, 1x Lamination Collar, 2m HD Lace, 1x Metal Lace Feeder, 3x Plastic Lace Feeders, 1x Reel Tool, 1.8m Lamination Tubing</p> <p>User Weight Limit: 300lb (135kg)</p>	
RF-200-07-10	RevoFit® Lamination Fabricators 10-Pack with Click® Reel	<p>The RevoFit® Lamination Fabricators 10-Pack with the Click® Reel is recommended for central fabricators and practices that create large volumes of adjustable devices.</p> <p>Save 10% on purchase price of each single kit while assuring you will always have a kit on hand.</p>	
RP-002	HD Lace Kit	2m of HD (High Durability) Lace and Click® Reel components for RevoFit® Lamination Kits with the Click® Reel.	
RP-002-07	Click® Reel and HD Lace Kit	<p>Replacement Click® Reel and 2m of HD (High Durability) Lace for RevoFit® Kits only.</p> <p>Note: This is not for replacing a BOA® dial. Please see RP0100-320-05 for replacing a BOA® dial.</p>	









RevoFit®

SKU	Product	Description	Picture
RP-200	Lamination Collar	Replacement Lamination Collar for RevoFit® & RevoLock Lamination Kits with the Click® Reel only.	
RP-201	Lamination Tube - 1.8m	Replacement Lamination Tube (1.8m) for all Revo Kits with the Click Reel and BOA® dials.	
BL-002	HD Lace - 25m Spool	<p>25m spool of HD (High Durability) Lace assures you will always have replacement lace on hand.</p> <p>Cost effective and sustainable with less waste.</p> <p>Compatible with both the RevoFit® Lamination Kit with the Click Reel and RevoFit® Lamination Kit with BOA® dial.</p>	
RP-300	Slider Part Kit	Replacement Slider and Lock Wire for dynamic AFOs, large gap prostheses or RevoLock® applications.	
RP-309	Slider Lamination Kit	Lamination Kit for fabricating new dynamic AFOs, large gap prostheses or replacement for RevoLock® Kits.	
AC-100-05	Comfort Grip Ring - Black 5-Pack	Provide a soft-touch feel and 10% increased turning power to the existing Click® Reel. Great for patients with dexterity issues.	
AC-101-05	Power Grip Ring - Black 5-Pack	Provide a soft-touch feel and 20% increased turning power to the existing Click® Reel. Great for patients with dexterity and hand strength issues.	
AC-000-00	Click® Care Kit	<p>The Click Care Kit enables you to service your clients in the office or on the road with everything readily accessible for maintaining, repairing or replacing Click components.</p> <p>Contents: 1x Surface Collar Kit, 2x HD Lace Kits, 2x HC Lace Kits, Flathead Screwdriver, Dental Pick, Spectra Scissors, Needle Nose Pliers & Reel Lubricant. Extra space is allocated for a Click® Reels and a lighter, which can be purchased separately.</p>	





SKU	Product	Description	Picture
RL-301-07-01	RevoLock® Align Kit with Click® Reel	<p>This single RevoLock Align Kit with the Click Reel is for transferable alignment fabrication for both upper and lower extremity sockets.</p> <p>The Click Reel innovation offers increased durability and power, a lower streamlined profile, and micro/macro adjustment that incrementally tightens and loosens. The Slider enhances safety for limbs changing in position or fluctuating in volume.</p> <p>Kit includes: 1x Click Reel, 1x Lamination Collar, 1x Slider Lamination Kit, 2x RevoLock LE Quick Connect Inserts, 1x RevoLock LE Quick Connect Snap, 2m HC Lace, 1x Metal Lace Feeder, 3x Plastic Lace Feeders, 1x Reel Tool, 0.5m Lamination Tubing, 1x Align Housing + Fabrication Post</p> <p>User Weight Limit: 300lb (135kg)</p>	
RL-300-07-01	RevoLock® 4-Hole Kit with Click® Reel	<p>This single RevoLock 4-Hole Kit with the Click Reel is for standard alignment fabrication for lower extremity sockets and comes with a standard 25mm x 65mm distal housing and integrated 4-Hole plate.</p> <p>The Click Reel innovation offers increased durability and power, a lower streamlined profile and micro/macro adjustment that incrementally tightens and loosens. The Slider enhances safety for limbs changing in position or fluctuating in volume. RevoLock® Tool Form required for fabrication of</p> <p>RevoLock 4-Hole kit. Kit includes: 1x Click Reel, 1x Lamination Collar, 1x Slider Lamination Kit, 2x RevoLock LE Quick Connect Inserts, 1x RevoLock LE Quick Connect Snap, 2m HC Lace, 1x Metal Lace Feeder, 3x Plastic Lace Feeders, 1x Reel Tool, 0.5m Lamination Tubing, 1x 4-Hole Puck, 1x Tool Form Plug</p> <p>User Weight Limit: 300lb (135kg)</p>	
RL-310-00-01	RevoLock® Tool Form	<p>The 25mm x 65mm RevoLock Fabrication Tool Form is a required, reusable fabrication tool for RevoLock® 4-Hole Kits.</p>	

SKU	Product	Description	Picture
RL-302-22-01	RevoLock® Lanyard V3 with BOA® Dial	<p>This kit offers the push to engage and pull to release interface of the BOA® Dial in a RevoLock Lanyard solution. It includes a shorter and smaller diameter distal housing which accepts the Quick Connect Snap for easy connection to the liner.</p> <p>Kit includes: 1x BOA® Lanyard Dial, 1x Lamination Collar, 1x 0.5m Lamination Tubing, 2x LE Quick Connect Inserts, 1x Quick Connect Snap, 1x Align Housing + Fabrication Post, 2x 1.22m HC Lace, 1x Metal Lace Feeder</p> <p>User Weight Limit: 220lb (100kg)</p>	
RP-310	RevoLock® V2 & V3 BOA® Dial and HC Lace Kit (Port C)	<p>Replacement 1x BOA® Lanyard Dial, 1.22m of HC Lace (High Capacity), 1x Metal Lace Feeder. For use with Port C Lace exit.</p> <p>Compatible only with RevoLock Lanyard V2 and V3 Kits</p>	
RP-310A	RevoLock® V2 & V3 BOA® Dial and HC Lace Kit (Port A)	<p>Replacement 1x BOA® Lanyard Dial, 1.22m of HC Lace (High Capacity), 1x Metal Lace Feeder. For use with Port A Lace exit.</p> <p>Compatible only with RevoLock Lanyard V2 and V3 Kits</p>	
RP-312	RevoLock® HC Lace Kit	<p>1.22m of HC Lace (High Capacity), 1x Metal Lace Feeder.</p> <p>Compatible only with RevoLock Lanyard V2 and V3 Kits</p>	
RP-001	HC Lace Kit	<p>2m of HC (High Capacity) Lace and Click Reel components for RevoLock Align, RevoLock® 4-Hole, and RevoSurface Tool Kits with the Click® Reel.</p>	
RP-000-07	Click® Reel and HC Lace Kit	<p>Replacement Click® Reel and 2m of HC (High Capacity) Lace for RevoLock Align, RevoLock® 4-Hole and RevoSurface Tool Kits only.</p> <p>This is not for replacing a BOA® dial. Please see RP0100-320-05 for replacing a BOA® dial.</p>	

RevoLock®

SKU	Product	Description	Picture
RP-200	Lamination Collar	Replacement Lamination Collar for RevoLock Align, RevoLock 4-Hole, RevoLock Lanyard V3 & RevoFit Lamination Kits.	
RP-201	Lamination Tube - 1.8	Replacement Lamination Tube (1.8m) for all Revo Kits with the Click Reel and BOA® dials.	
RP-305	RevoLock® Tool Form Plug 5-Pack	The RevoLock Tool Form Plug 5-Pack is to ensure fabricators have extra plugs on hand.	
RP-300	Slider Part Kit	Replacement Slider and Lock Wire for dynamic AFOs, large gap prostheses or RevoLock applications.	
RP-309	Slider Lamination Kit	Lamination Kit for fabricating new dynamic AFOs, large gap prostheses or replacement for RevoLock Kits.	
BL-001	HC Lace - 25m Spool	25m spool of HC (High Capacity) Lace assures you will always have replacement lace on hand. Cost effective, sustainable and less waste. Used in the RevoSurface and RevoLock Kits with the Click Reel only.	
AC-100-05	Comfort Grip Ring - Black 5-Pack	Provide a soft-touch feel and 10% increased turning power to the existing Click Reel. Great for patients with dexterity issues.	
AC-101-05	Power Grip Ring - Black 5-Pack	Provide a soft-touch feel and 20% increased turning power to the existing Click Reel. Great for patients with dexterity and hand strength issues.	
RP-306	RevoLock® UE Fixed Insert	RevoLock Fixed Threaded Insert (M6) for upper extremity and pediatric liners. Compatible with RevoLock 4-Hole, RevoLock Align and RevoLock Lanyard V3 Kits. Best for patients who cannot operate the RevoLock Quick Connect Snap or for suction systems needing an airtight seal. This part is NOT releasable and does not connect to the RevoLock LE Quick Connect Snap.	

RevoLock®



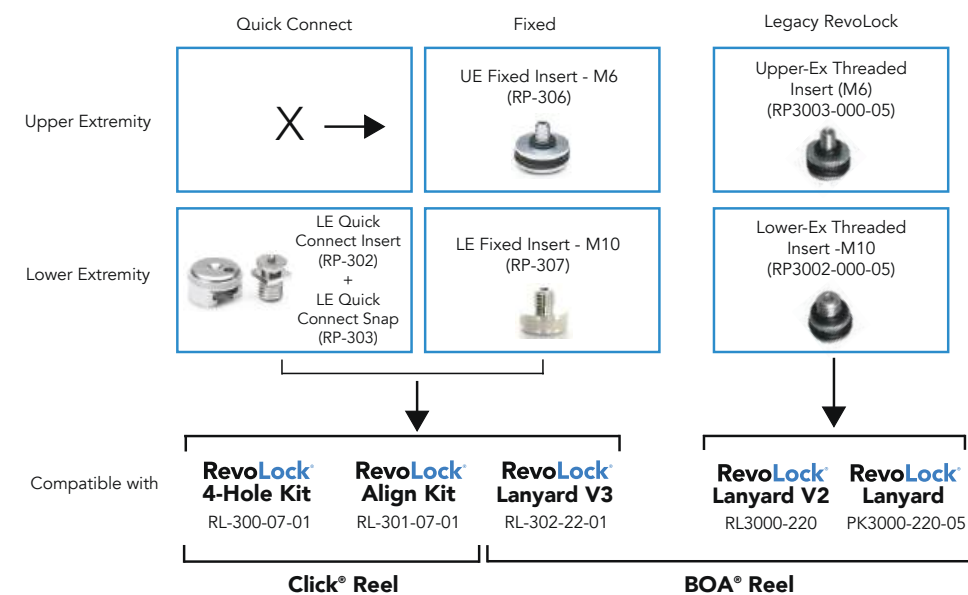

SKU	Product	Description	Picture
RP-307	RevoLock® LE Fixed Insert	RevoLock Fixed Threaded Insert (M10) for lower extremity liners only. Compatible with RevoLock 4-Hole, RevoLock Align and RevoLock Lanyard V3 Kits. Best for patients who cannot operate the RevoLock Quick Connect Snap or suction systems needing an airtight seal. This part is NOT releasable and does not connect to the RevoLock LE Quick Connect Snap.	
RP-303	RevoLock® LE Quick Connect Snap	Replacement RevoLock LE Quick Connect Snap connects the HC (High Capacity) Lace to the liner via the RevoLock LE Quick Connect Insert (RP-302).	
RP-302	RevoLock® LE Quick Connect Insert	Replacement RevoLock LE Quick Connect Insert for connection to lower extremity liners. Compatible with RevoLock LE Quick Connect Snap (RP-303) found in the RevoLock Align, RevoLock 4-Hole and RevoLock Lanyard V3 Kits. Often purchased for outfitting additional patient liners.	
AC-000-00	Click® Care Kit	The Click Care Kit enables you to service your clients in the office or on the road with everything readily accessible for maintaining, repairing or replacing Click components. Contents: 1x Surface Collar Kit, 2x HD Lace Kits, 2x HC Lace Kits, Flathead Screwdriver, Dental Pick, Spectra Scissors, Needle Nose Pliers & Reel Lubricant. Extra space is allocated for a Click® Reels and a lighter, which can be purchased separately.	



QuickFit®
Made with the BOA® Dial

SKU	Product	Description	Picture
OK0180-130-05	QuickFit® Lacer, XS	The extra small size QuickFit Lacer is designed to close a small region of an orthosis, a pediatric sized orthosis, or pediatric footwear up to size 35 EU. Comes pre assembled with a low-profile dial and 4 guides. QuickFit Rivets sold separately, but are required to install the QuickFit Lacer kits. Lacers are sold individually. For a pair of shoes, two kits are required.	
OK0185-130-05	QuickFit® Lacer, XS 10-Pack	The extra small size QuickFit Lacer is designed to close a small region of an orthosis, a pediatric sized orthosis, or pediatric footwear up to size 35 EU. Comes pre assembled with 10 extra small QuickFit Lacer kits and 100 QuickFit Rivets. For a pair of shoes, two kits are required.	N/A
OK0200-130-05	QuickFit® Lacer, SM	The small size QuickFit Lacer is designed to close a small region of an orthosis, a small sized orthosis, or footwear size 36 - 41 EU. Comes pre assembled with a low profile dial and 6 guides. QuickFit Rivets sold separately, but are required to install the QuickFit Lacer kits. Lacers are sold individually. For a pair of shoes, two kits are required.	
OK0205-130-05	QuickFit® Lacer, SM 10-Pack	The small size QuickFit Lacer is designed to close a small region of an orthosis, a small sized orthosis, or footwear size 36 - 41 EU. It comes with 10 Small QuickFit Lacer kits and 100 QuickFit Rivets. For a pair of shoes, two kits are required.	N/A
OK0220-130-05	QuickFit® Lacer, MD	The medium size QuickFit Lacer is designed to close a medium sized orthosis or footwear size 42 EU and larger. Comes pre assembled with a low profile dial and 8 guides. QuickFit Rivets sold separately, but are required to install the QuickFit Lacer kits. Lacers are sold individually. For a pair of shoes, two kits are required.	





QuickFit®
Made with the BOA® Dial

SKU	Product	Description	Picture
OK0225-130-05	QuickFit® Lacer, MD 10-Pack	The medium size QuickFit Lacer is designed to close a medium sized orthosis or footwear size 42 EU and larger. It comes with 10 Medium QuickFit Lacer kits and 100 QuickFit Rivets. For a pair of shoes, two kits are required.	N/A
OK0240-130-05	QuickFit® Lacer, LG	Designed to close or secure above the ankle shoes or orthoses, such as a Leather AFO's, plastic rigid AFO's, or Crow boots. Can also be used on footwear such as hiking boots. Comes pre assembled with a more powerful dial and 10 guides. Rivets sold separately.	
OK0165-230	QuickFit® Releasing Lacer, LG	Adds opening functionality to our QuickFit Lacer by adding releasing guides to one side so that the system can fully open like a door for easy donning. Comes with a more powerful reel to close larger devices. This kit is unassembled with 4 fixed guides and 3 releasing guides. Rivets sold separately.	
TL-001	QuickFit® Tool	The QuickFit Tool is customized for use with QuickFit Rivets and is the recommended installation tool. The QuickFit Tool properly secures rivets and provides either an 1/8" and 3/16" rivet hole.	
SP1040	QuickFit® Rivets 100-Pack	QuickFit Rivets come in packs of 100. You can supply your own rivets, or purchase our easy to use rivet pack to install QuickFit Lacers to any device or shoe.	



Notes:

SKU	Product	Description	Picture
RP0200-130-05	QuickFit® XS/SM/MD Dial and Lace Replacement Kit	Replacement BOA® dial and 1.5m of Low-Mid Power Steel Lace for XS/SM/MD size QuickFit® Lacers using BOA® dials.	
RP0200-230-05	QuickFit® LG Dial and Lace Replacement Kit	Replacement BOA® dial and 2m of compatible Low-Mid Power Steel Lace for LG size QuickFit Lacers using BOA® dials.	
LOK019	Low-Mid Power Steel Lace - 10m Spool	Bulk replacement Low-Mid Power Steel Lace (10m spool compatible only with BOA® dials and QuickFit Lacer kits. NOT COMPATIBLE with Click® Reel.	
OK1410-130-05	QuickFit® Strap 1.5"	QuickFit Straps are designed to quickly install on a wide variety of cuffs, orthoses, and prosthetic devices to create an improved, easy to use, adjustable strap. <ul style="list-style-type: none"> • Prefabricated, durable, and installs in minutes • Don/doff via simple Velcro® closure • 76mm (3") of adjustable travel • Usable strap length: Max: 0.75m (30") / Min: 0.2m (9") • Cut to size • Width (38mm) 	
OK1415-000-05	QuickFit® Buckle 1.5"	The QuickFit Buckle can be added onto the QuickFit Strap in a few seconds. The magnetic buckle allows the user to easily connect the strap - even with limited dexterity or in hard to reach areas. Its plastic on plastic interface eliminates wear issues of Velcro® closure. <ul style="list-style-type: none"> • Easily adds onto QuickFit Strap in seconds • Adds 76mm (3") to strap usable length • 5mm (.2") profile • Width (38mm) 	

Replacement Parts

SKU	Product	Description	Picture
PK0060-000-10	RevoFit® Re-Lacing Kit for BOA® dial	2m of HD (High Durability) Lace for RevoFit Lamination Kits. Compatible only with RevoFit Kits with BOA® dial.	
RP0100-320-05	RevoFit® Dial and Lace Replacement Kit with BOA® dial	Replacement BOA® dial and 2m of HD (High Durability) Lace Compatible only with RevoFit Kits with BOA® dial.	
RP3000-220-05	RevoLock® Lanyard Dial and Lace Replacement Kit with BOA® dial	Replacement BOA® dial and 1.2m of lace Compatible only with RevoLock Kits with BOA® dial. Not compatible with RevoLock V2 and V3 Kits.	
RP3001-000-05	RevoLock® Lanyard Re-Lacing Kit for BOA® dial	Contains 1.2m of lace Compatible only with RevoLock® Kits with BOA® dial. Not compatible with RevoLock® V2 and V3 Kits.	

Replacement Parts

SKU	Product	Description	Picture
RP3002-000-05	RevoLock® Lanyard - Lower-Ex Threaded Insert (10mm)	Replacement RevoLock Lower-Extremity Threaded Insert which attaches the lace to the liner via a threaded connection. Compatible only with RevoLock Lanyard and RevoLock Lanyard V2 Kits with BOA® dial.	
RP3003-000-05	RevoLock® Lanyard - Upper-Ex Threaded Insert (6mm)	Replacement RevoLock Upper-Extremity Threaded Insert which attaches the lace to the liner via a threaded connection. Compatible only with RevoLock Lanyard and RevoLock Lanyard V2 Kits with BOA® dial.	

DIGITAL CATALOG FOUND HERE

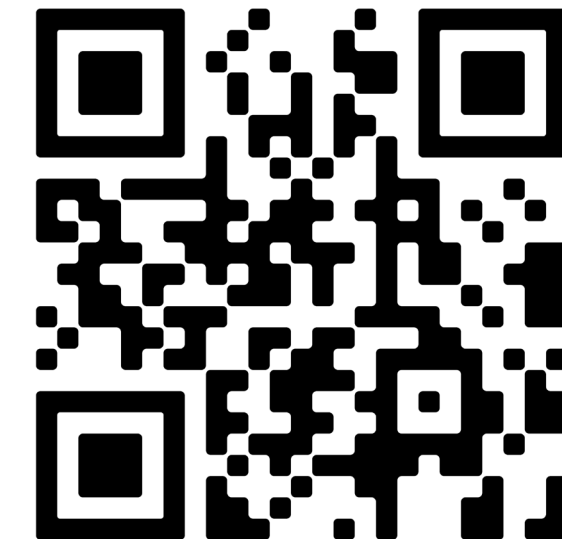

Find Click Medical® Adjustable Solutions Worldwide



DISTRIBUTOR	COUNTRIES	ADDRESS	PHONE	WEB ADDRESS
NORTH AMERICA				
SPS	United States (includes Puerto Rico)	6530 Corporate Court Alpharetta, GA 30005 United States	Tel: +1 (800) 767-7776 ext.3	spsco.com
Cascade	United States (includes Puerto Rico) / Canada	2638 Aztec Drive Chico, CA 95928 United States	Tel: +1 (800) 888-0865	cascade-usa.com
OrtoPed	Canada	373 Rue McCaffrey Montréal, QC H4T 1Z7 Canada	Tel: +1 (514) 342-6161	ortoped.ca
PEL Supply	United States	4666 Manufacturing Avenue Cleveland, OH 44135-2672 United States	Tel: 1-800-321-1264	pelsupply.com
Ortiz International	Mexico	Federalismo Sur 836 Guadalajara, Jalisco, 44190 Mexico	Tel: +33 3811-2151 6 3811-3827	ortizinternacional.com.mx
EUROPE				
Alfimed AS	Norway, Sweden, Denmark, Finland	Olav Brunborgs vei 6 1396 Billingstad Norway	Tel: +47 31 29 68 86	alfimed.no
EMO	Spain, Portugal	Camino Pascualeta, 40. 46200 Paiporta, Spain	Tel: +34 963 132 051	emo.es/es
Frey Orthopädie-Bedarf AG	Switzerland	Panoramaweg 35 5504 Othmarsingen Switzerland	Tel: +41 62 887 45 00	freyortho.ch/en
Janton Solutions	France	Chemin des Aubrières 49400 Saumur France	Tel: +(33) 2 41 50 50 91	janton-g2m.com
ING Corporation	Czech Republic, Romania, Slovakia, Croatia, Latvia	Mánesova 1259, 739 11 Frýdlant nad Ostravicí Czech Republic	Tel: +(420) 558 663 217	ingcorporation.cz
Mediroyal	Norway, Sweden, Denmark, Finland, Iceland, Estonia	Box 7052 Staffans väg 6 B S-192 07 Sollentuna Stockholm, Sweden	Tel: +46 8 506 766 00	mediroyal.se/en

Metiz IMPEX	Russia	Kolpakova 24/A, Mytischki, Moscow region, 141008 Kolpakova 24/A Mytischki, Moscow region 141008 Russia	Tel: +7 (495) 215-53-82	metiz-ltd.com
BeMedico	Belgium, Netherlands, Luxembourg	Mutsaardstraat 47 9550 Herzele, Belgium	Tel: +32 (0) 54 50 40 05	bemedico.be
Ottobock	Germany, (worldwide)	Max-Näder-Straße 15 (or Max-Naeder-Strasse 15) D-37115 Duderstadt, Germany	Tel: +49 5527 848-0	ottobock.com
Protheseus GmbH	Germany, Austria	Liebigstraße 13 91126 Schwabach, Germany	Tel: +49 (0) 9122 88 707-0	protheseus.de
Invapol	Ukraine	Akademika Kymys'koho 27 Kyiv, UA, 3680	Tel: +38 0502321540	invapol.com
Simex	Ukraine	Building 3, Letter "U", str. Glubochitska 17 Kiev, Ukraine, 04050	Tel: +(38) 044 4861406	parasind.com
Steeper	UK, Ireland	Unit 3, Stourton Link Intermezzo Drive Leeds LS10 1BL UK	Tel: (+44) 0 113 270 4841	steepergroup.com
MIDDLE EAST				
Gilron	Israel	2 Haron Katzir Ave Tel-Hashomer, Ramat-Gan, Israel	Tel: +(972) 3-5409333	gilron.com
OrthoMENA	United Arab Emirates	Dubai Real Estate Centre 153 Al Mina road 1st Floor, 103 Al Hudaiba, Dubai	Tel: 0097148357207	orthomena.com
AUSTRALIA				
OttoBock Australia Pty. Ltd.	Australia, New Zealand	Suite 1.01, Century Corporate Centre 62 Norwest Boulevard, Baulkham Hills, NSW, 2153, Australia	Tel: +61 2 8818-2800	ottobock.com.au
ASIA				
Imasen Engineering Corporation	Japan	3-1-8 Techno Plaza Kakamigahara Gifu JAPAN 509-0109	Tel: +(81) 90-2348-9484	imasengiken.co.jp
Teh Lin Prosthetic & Orthopaedic Inc.	China, Taiwan	No.7, Wuquan 7th Rd., Wugu Dist., New Taipei City 248 New Taipei City, Taiwan 248 Taiwan, China	Tel: +(886) 2-22991901	tehlin.com
SOUTH AMERICA				
BM Medicine SRL	Argentina	Bernardo De Irigoyen 1312 Buenos Aires, Capital Federal 1138 Argentina	Tel: +5491136252594	bmmedicine.com.ar
Ethnos	Brazil	Rua 15 de Novembro, 469, Vila São Luiz, Duque de Caxias Rio de Janeiro, Brazil	Tel: +55 21 2775 4032	ethnos.com.br
Orthopedix Argentina	Argentina	Av Cordoba, 5328, 1ªA, Buenos Aires 1414, Argentina	Tel: +541147758208	orthopedixargentina.com.ar

Innovation, Outcomes, Reimbursement

Reimbursement varies by country.

There are several International codes established. Please ask your distributor for information specific to your country.

RevoFit® and RevoSurface®

Custom Lower Extremity

Prosthesis - L5783: Addition to lower extremity, user adjustable, mechanical, limb volume management system. Applicable to all LE amputation levels across all activity levels. Appropriate for new, replacement, and preparatory sockets.



Custom Upper Extremity Prosthesis - New Code Effective

04/01/2025, L7406: Addition to upper extremity, user adjustable, mechanical, residual limb volume management system to describe RevoFit®. Prior to 04/01/2025, continue to utilize L7499 (Reference L5783 as Same/Similar and pending activation of L7406), and, supply Click Medical's RevoFit MSRP for upper extremity prosthetic devices and our suggested descriptive language.

Custom Orthosis - L2999 (Reference L5783 as Same/Similar):

Additionally, utilize Click Medical's RevoFit MSRP for orthotic devices and our suggested descriptive language. Appropriate for new, replacement, and modified Dynamic AFO and KAFO custom laminated devices.

Repair of an Existing Prosthesis - L7510: For cost of materials and L7520 for repair labor components. Appropriate for RevoFit replacement parts and labor to install.

Repair of an Existing Orthosis - L4210: For cost of materials and L4205 for repair labor components. Appropriate for RevoFit replacement parts and labor to install.

RevoLock® 4-Hole & Align

Lower Extremity Prosthesis - L5671: Addition to lower extremity, below knee/above knee suspension locking mechanism (shuttle, lanyard, or equal), excludes socket insert.

Upper Extremity Prosthesis - L6698: Addition to upper extremity prosthesis, below elbow/above elbow, lock mechanism, excludes socket insert.

Repair of an Existing Prosthesis - L7510: For cost of materials and L7520 for repair labor components. Appropriate for RevoLock replacement parts and labor to install.

Repair of an Existing Orthosis - L4210: For cost of materials and L4205 for repair labor components. Appropriate for RevoLock replacement parts and labor to install.

QuickFit®

Lower Extremity Custom Orthosis - L2320: Addition of lacer to lower extremity, non-molded lacer, for custom fabricated orthosis only.

Lower Extremity Custom Orthosis - L2330: Addition of lacer to lower extremity, lacer molded to patient model, for custom fabricated orthosis.

Orthotic Shoes - L2999 (Reference L3580 as Same/Similar): Addition of lacer to orthopedic shoe, convert instep to velcro closure.

Addition to/Repair of Orthosis - L4002: Replacement strap for any orthosis that includes all components and can be any length or type.

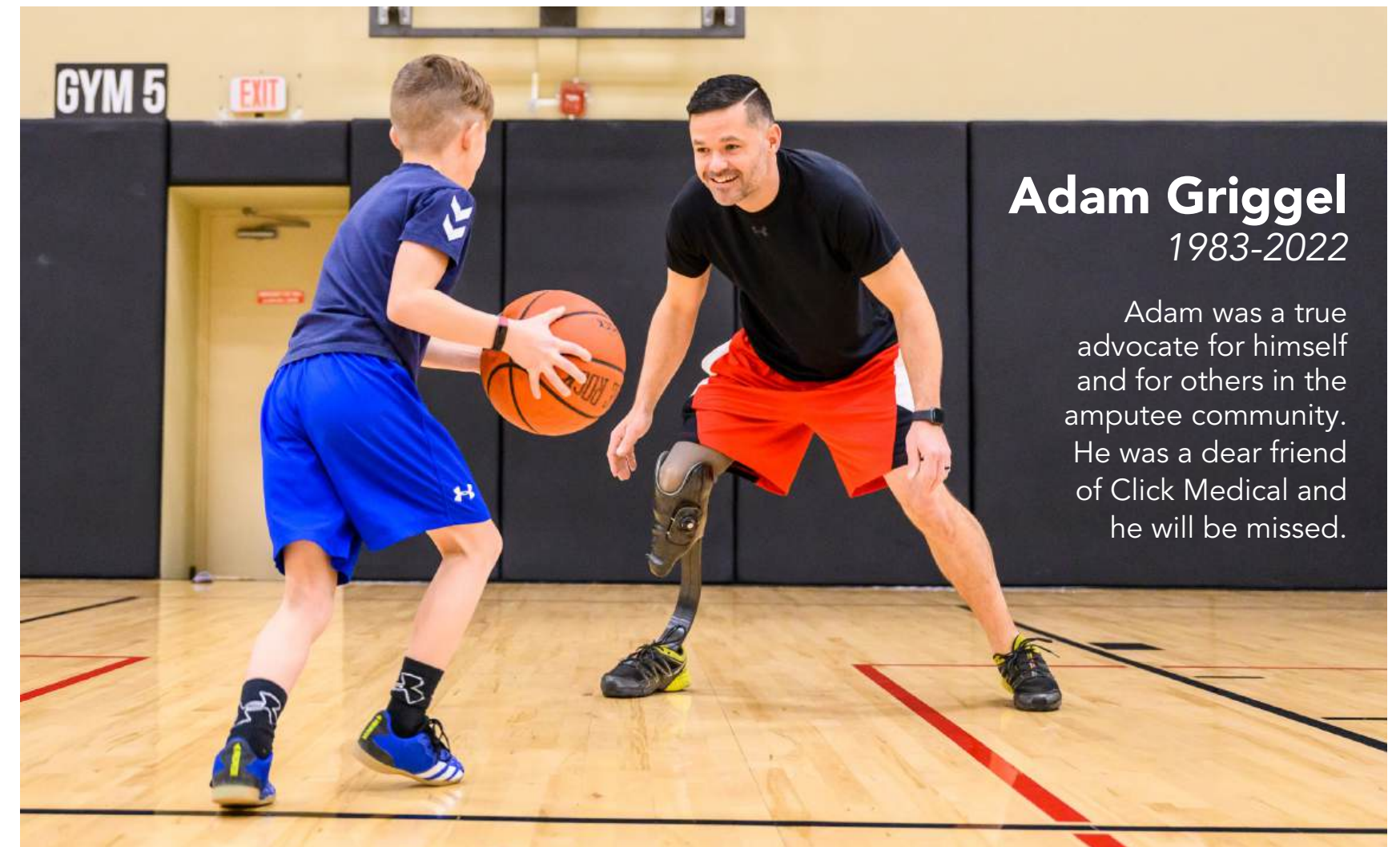

Adam Griggel 1983-2022

Adam was a true advocate for himself and for others in the amputee community. He was a dear friend of Click Medical and he will be missed.

Adam Griggel, RevoFit user and son, Lincoln.

Questions?

We are here for you!

Technical Support

Monday - Thursday, 9am - 5pm MST
Friday, 9 am - 3 pm MST
+1 (970) 670-7012

Online Support Form:

clickmedical.co/contact-us

Click Medical

1205 Hilltop Parkway, W101
PO Box 775245
Steamboat Springs, CO
80487



Power
— *to* —

ADJUST
SOLVE
CHANGE LIVES



clickmedical.co

