

Click® Reel + HC/HD Lace Kit

RP-000-07 (HC), RP-002-07 (HD)

For more resources, visit clickmedical.co

Visit www.clickacademy.co for important videos and instructions on working with Click Reels



Advisories

Must be installed by a licensed professional.
Overtightening could compromise circulation.
Lace will wear:

- Routinely check for wear or damage.
- Look for broken fibers around areas of high wear.
- Replace lace if a significant amount of fibers are broken.
- Proactively replace lace every 6 months.
- Keep lace away from open flame and sharp edges.

Weight limit: 300lbs/135kg

See instructions in other languages: clickmedical.co/instructions

Lace

High Capacity (HC) - For use with **RevoLock®** and **RevoSurface®**
High Durability (HD) - For use with **RevoFit®**

GUARANTEE

The Click Reel is guaranteed to last the life of the device into which it is originally installed. Registration of the Click Reel is required at the time of original device delivery. To register: clickmedical.co/contact-us/cr-registration

WARRANTY

For warranty information on all of Click Medical's products: clickmedical.co/terms/#warranty

U.S. Customers:

Contact Help@ClickMedical.co
Tel: +1-970-670-7012

International Customers:

Please contact your local distributor.

Click Medical products are patent protected.

For full list see www.clickmedical.co/patents

Kit Contents:

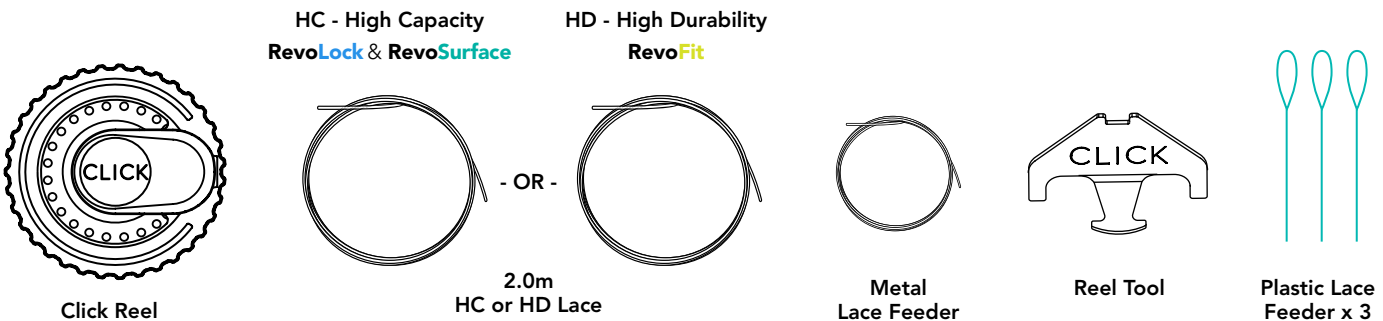

Replacing a Click Reel

1 Remove existing reel from device:

- Locate the metal insert.
- Insert a small flathead screwdriver between the metal insert and the reel body.
- Gently pry the reel upwards.
- Cut lace and remove all lace from device.

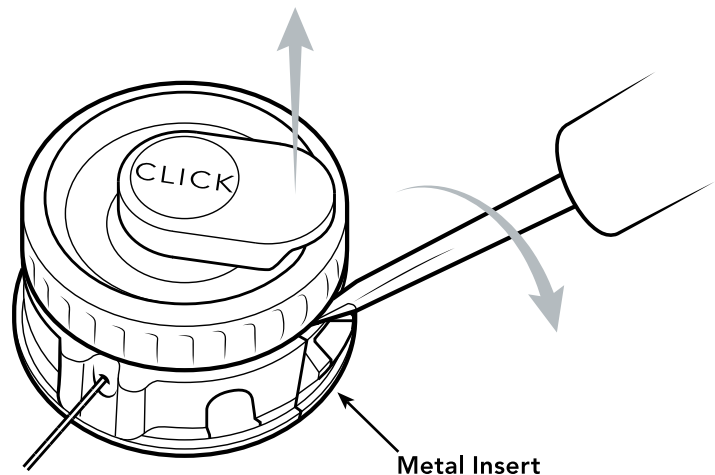

Additional Designs: To learn more about designing adjustable RevoFit devices, enroll in ClickAcademy.co

2 Attach lace to the Click Reel:

Step 1

Ensure that the reel is ready for lacing. Both lock plugs should be in place. The **green marks** on the spool should align with the **green marks** on the washer. If necessary, turn dial to align **green marks**.

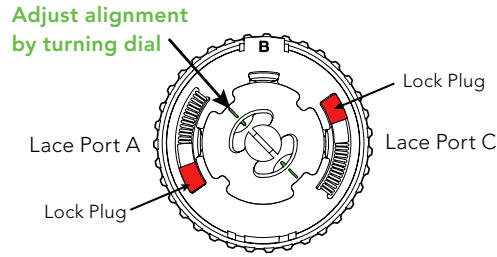

Step 2

Relace the device. Attach each lace to its corresponding lace port on the reel - A, B, or C.

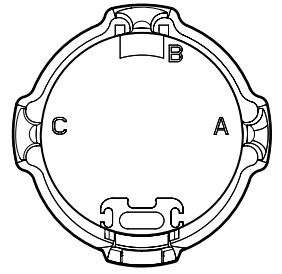

Step 3

Lace the reel using the plastic lace feeder.

Pro Tip:

Gently pull the lace through the cavity to avoid breaking the plastic lace feeder.

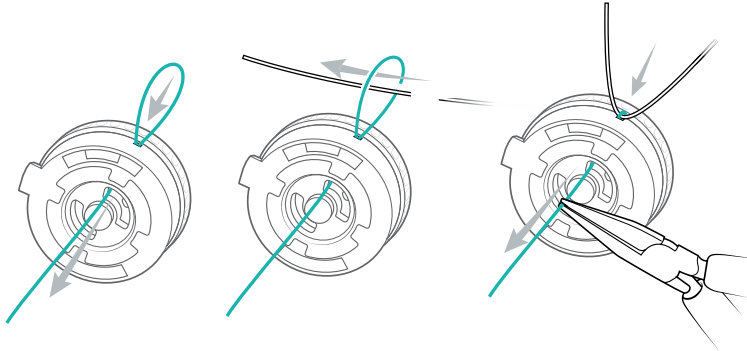

Step 4

Tie a **single overhand** knot for the HD Lace (1) and a **double overhand** knot for the HC Lace (2). Trim tail to <5mm and lightly burn the end of the tail.

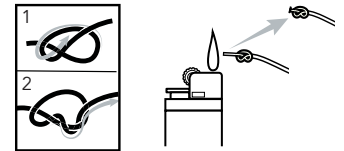

Step 5

Pull lace to seat knot in the far lace pocket, on the opposite side of the **green marker**.

Completely push knot into the cavity with a #1 flathead screwdriver:

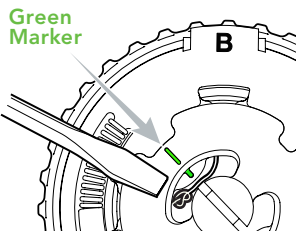

Step 6

Pull open lace end to remove loose lace from device.

Repeat Step 3 to feed open lace end through reel.

Measure out ~10cm of lace.

Repeat Step 4 to tie double overhand knot, trim and seat it.

Pro Tip: For RevoLock applications measure out enough lace to match patient limb length specifications.

Step 7

Decide which reel mode to activate:

For more information on reel modes, watch our video here: <https://vimeo.com/786989811>

ADJUSTABLE DESIGNS WITH
Less than 3" of lace uptake

75% of Applications

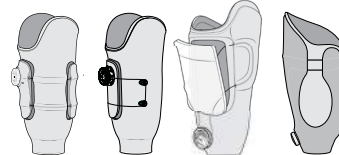

Keep Red Lock Plugs installed in the reel.

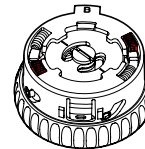

ADJUSTABLE DESIGNS WITH
More than 3" of lace uptake

25% of Applications

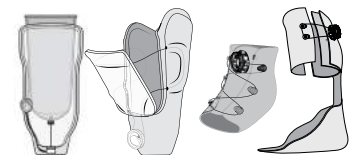

Remove Red Lock Plugs after lacing the reel.

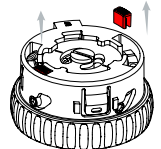

Pro Tip: Central fabricators should deliver device with Red Lock Plugs installed in reel. This will allow the practitioner to decide if they want Power Mode or Shift Mode.

3 Install the Click Reel:

a. Insert the foot of the reel into the void in the bottom of the collar opposite of the metal insert.

b. Press the reel firmly into the collar (you should hear a "CLICK" when secure).

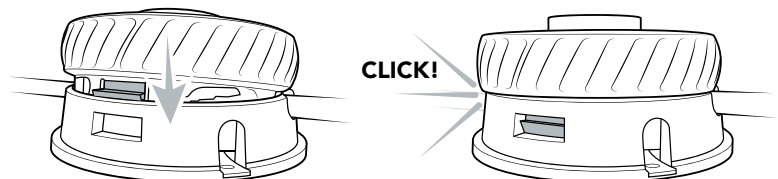
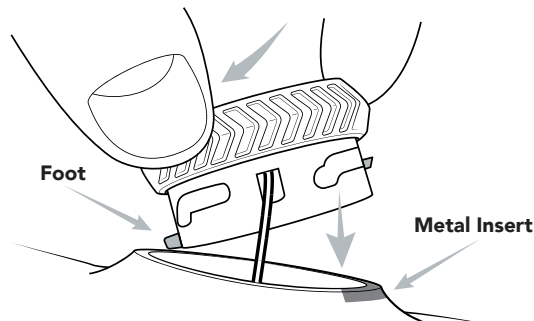

4 Test function:

Cycle the system 3 times before delivering to verify proper function.

5 Important.

As a final step of fabrication, attach the patient **Instructions For Use** hangtag on dial.

How to use the Click Reel

The reel can operate in either Power Mode or Shift Mode.
If you want to change between modes, see our video on the process here: <https://vimeo.com/786989811>

How to operate the Click® Reel in **Power Mode - With Red Lock Plugs**

- 1 Turn the dial clockwise to tighten to desired tension.
- 2 Turn the dial counterclockwise to release tension.
- 3 Micro-adjust as needed.

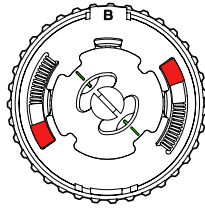

If the reel always clicks when turned, it is in Power Mode

How to operate the Click® Reel in **Shift Mode - Without Red Lock Plugs**

- 1 Turn reel clockwise to quickly take up lace.
- 2 Continue to turn the dial. It will automatically shift from "silent" to "clicking".
- 3 Micro-adjust by turning forward or backward.
- 4 To fully release lace, unwind counterclockwise until "clicking" stops. Lace will then freely release from the reel.



Reel will operate silently while taking up lace



Once clicking, the reel will hold lace tension and wind up lace at a higher power



Regularly inspect your system.



Inspect lace:

- ✓ Check for wear or damage routinely
- ✓ Replace at any sign of wear
- ✓ Replace lace every 6 months



This product is waterproof and submersible. Rinse with fresh water after use in saltwater, sand, or mud.

UK REP MDSS-UK RP LIMITED, 6 Wilmslow Road
Rusholme, M14 5TP Manchester
United Kingdom

CH REP MDSS CH GmbH, Laurenzenvorstadt 61
5000 Aarau, Switzerland

MD MDSS GmbH, Schiffgraben 41
30175 Hannover, Germany

EC REP 



Click Medical, LLC, 1205 Hilltop Parkway, W101
Steamboat Springs, CO 80487, USA +1-970-670-7012