

Visit [www.clickacademy.co](http://www.clickacademy.co) for important video education on Click Reels and RevoLock operation



### Advisories

Must be installed by a licensed professional.

Lace will wear:

- Routinely check for wear or damage.
- Look for broken fibers around areas of high wear.
- Replace lace if a significant amount of fibers are broken.
- Proactively replace lace every 6 months.
- Loss of suspension can occur if lace fails.
- Keep lace away from open flame and sharp edges.

Secure threaded insert to liner with medium thread lock.

Secure snap to threaded insert before tensioning system.

**Weight limit:** 300lbs/135kg

See instructions in other languages: [clickmedical.co/instructions](http://clickmedical.co/instructions)

**Tool Form for fabrication is sold separately;**

**Click Part Number: RL-310-00-01**

### GUARANTEE

The Click Reel is guaranteed to last the life of the device into which it is originally installed. Registration of the Click Reel is required at the time of original device delivery. To register: [clickmedical.co/contact-us/cr-registration/](http://clickmedical.co/contact-us/cr-registration/)

### WARRANTY

For warranty information on all of Click Medical's products: [clickmedical.co/terms/#warranty](http://clickmedical.co/terms/#warranty)

### U.S. Customers:

Contact [Help@ClickMedical.co](mailto:Help@ClickMedical.co)

Tel: +1-970-670-7012

### International Customers:

Please contact your local distributor.

**Click Medical products are patent protected.**

For full list see [www.clickmedical.co/patents](http://www.clickmedical.co/patents)

## RevoLock 4-Hole Kit Contents:

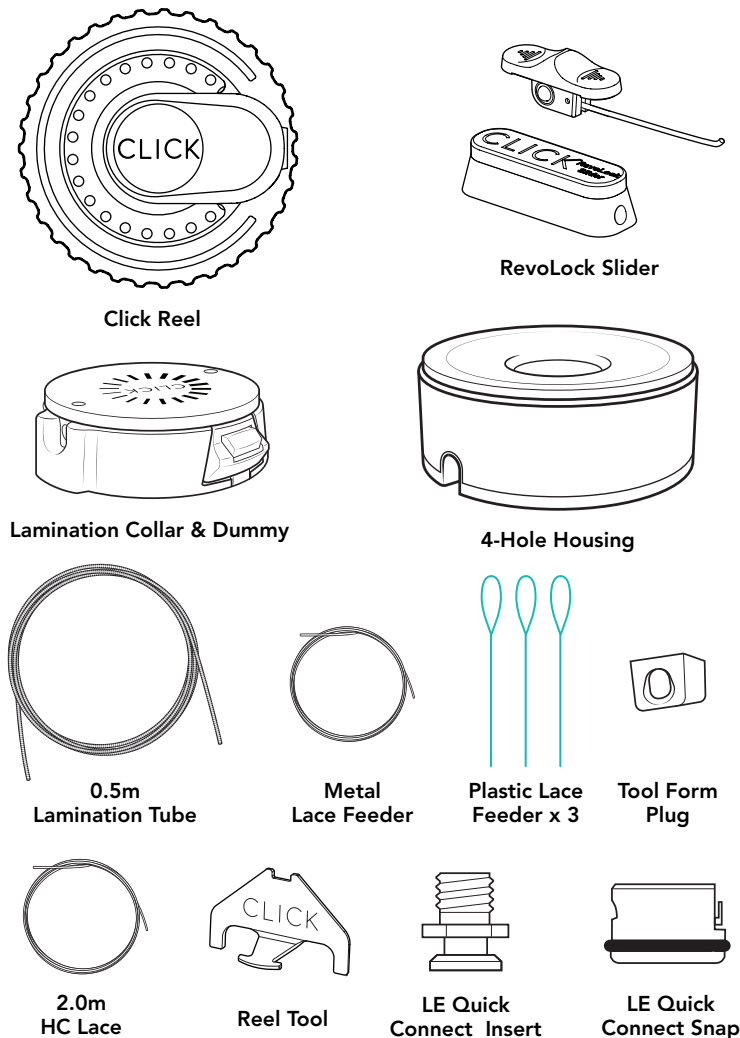

## Overview of Possible Applications:

### Fabricate a New Socket:

1. Determine location of Click Reel.
2. Secure tool form to model.
3. Apply PVA bag.
4. Apply inner fabric layers.
5. Insert tube into the tool form plug and the reel collar.
6. Apply outer fabric layers.
7. Laminate.
8. Remove tool form and install distal housing.
9. Lace device, then attach lace to the Click Reel and the snap.
10. Install Click Reel into the collar.
11. Test for function.

### Replace a Problem Pin Lock:

1. Remove old pin lock distal housing.
2. Insert and attach RevoLock distal housing.
3. Route tubing from distal housing slot through old pin lock hole.
4. Determine Click Reel location and bond collar to socket frame.
5. Cut tubing to length, insert into collar, bond tubing to socket.
6. Remove silicone from collar.
7. Feed lace through collar, tubing and distal housing.
8. Attach lace to snap.
9. Attach the other lace end to the Click Reel and install into collar.
10. Attach threaded insert into liner.
11. Connect threaded insert to snap.
12. Test for function.

## Detailed Fabrication Instructions:

RevoLock can be fabricated using a single stage or double stage lamination process:

- **For single stage:** follow steps 1-10, then skip to step 18
- **For double stage:** follow steps 1-8, then skip to step 11

For material suggestions and guidelines, please refer to the **Material Data Sheet:** [clickmedical.co/mds](http://clickmedical.co/mds)

- 1 Prepare the inner tool form by inserting a tool form plug into the base.**

**Note:** Tool form plugs are found in each RevoLock Kit.

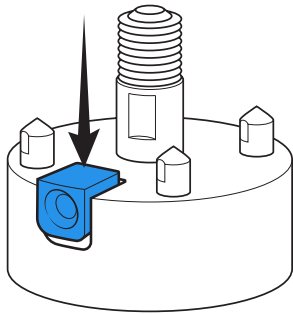

- 2 Determine desired location of reel and mark on the model.**

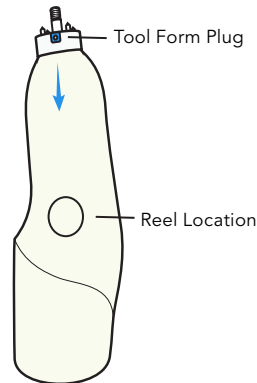

- 3 Orient the tool form plug with the collar and secure with plaster to the model.**

**Pro Tip:**  
Use hook and loop fastener dots on the inner form to adhere to plaster.

- 4 Apply inner PVA bag:**

- a. Tape bag to metal form, remembering to allow access to the plug.
- b. Trim excess.

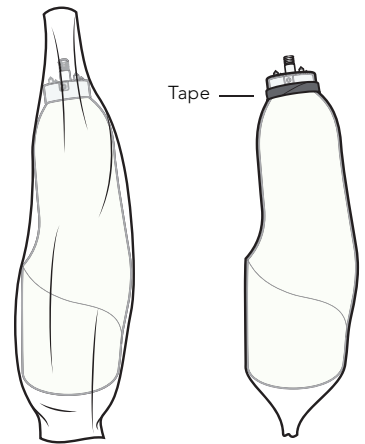

- 5 Apply inner fabric layers:**

Use a hot pick to create access holes for the plug and the 4 pins.

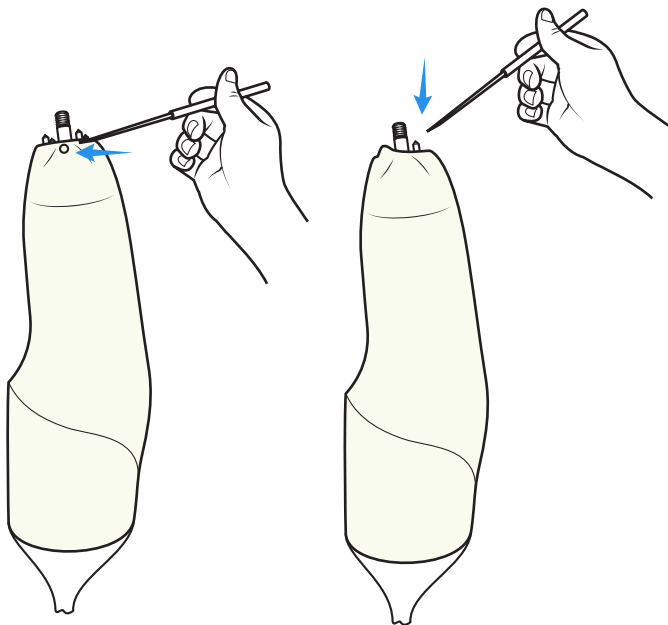

- 6 Install the tubing:**

- a. Pack tube end with 1cm of clay.
- b. Fully insert one end into tool form plug.
- c. Measure the distance from the plug to the collar.
- d. Cut tube to length, pack with clay and insert into collar via **Lace Port C**. Leave room proximally on the socket for the slider that is installed in Step 7.

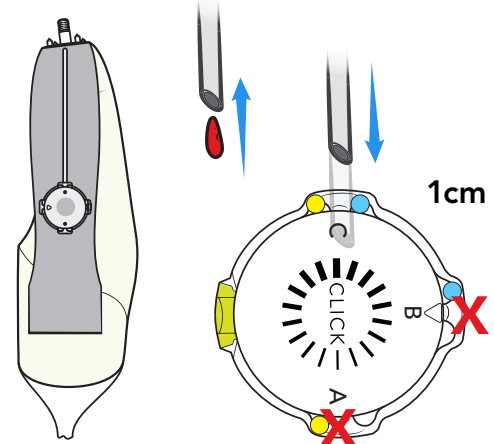

**-- DO NOT KINK THE TUBE --**

If the tube kinks, you must replace with a new piece.

## Detailed Fabrication Instructions (continued):

### 7 Install RevoLock Slider Base and Tubing:

**Purpose:** The RevoLock Slider locks the reel into Power Mode and prevents unintentional full release of lace.

a. Plug both ends of Slider Tube with clay.



b. Insert tube into Slider Base.  
Insert fully - at least 1cm.

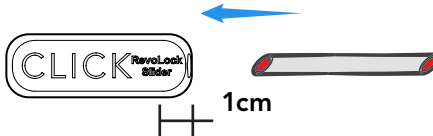

c. Insert free end of tube into Lamination Collar opposite of the tubing inserted in step 6 (Lace Port A).  
Insert fully - at least 1cm.

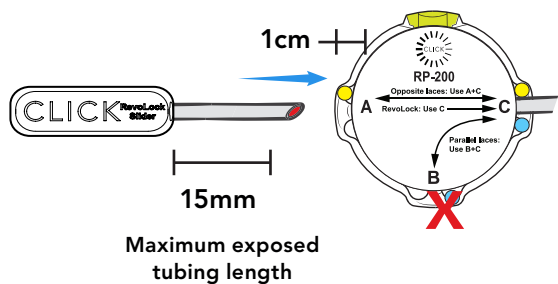

d. Place Lamination Collar and Slider Base in desired location.

**Pro Tip:**  
Use light spray adhesive if necessary.

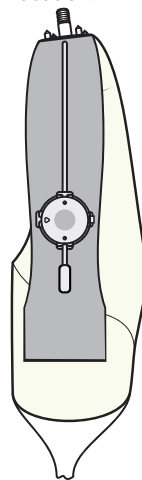

e. Use additional material to fill in under tubing for support.



**! DO NOT EXCEED 15 inHG OF VACUUM PRESSURE DURING LAMINATION  
REDUCE VACUUM TO ALLOW INNER LAYERS TO FULLY SATURATE DURING LAMINATION**

8 Apply outer fabric layers.

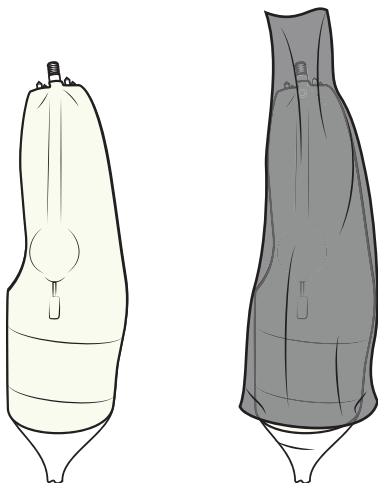

9 Apply outer former and nut.  
Clay the 2 small holes on top of nut.



10 Apply outer PVA bag and laminate.

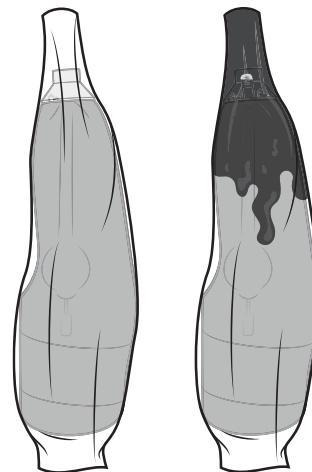

**! REMINDER**

- For single stage: follow steps 1-10, then skip to step 18
- For double stage: follow steps 1-8, then skip to step 11

## Detailed Fabrication Instructions (continued):

- 11** Add plastic spacer plate to create void for 2nd lamination, then apply outer former and compression nut.

Clay the 2 small holes on top of nut.

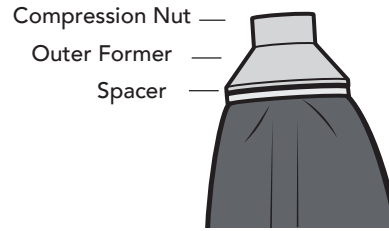

- 12** Apply outer PVA bag.
- 13** Perform 1st lamination.
- 14** Remove compression nut, outer former and spacer plate.
- 15** Apply outer fabric layers. Then reapply the outer former and compression nut.
- 16** Apply outer PVA bag.
- 17** Perform 2nd lamination.

**Optional:** If also adding RevoFit® adjustability, install those components now.

## For All Laminations, Complete These Final Steps:

- 18** Tool Form removal:

- Remove compression nut.
- Place parting tool onto the outer former.
- Screw 2 attachment bolts through parting tool and into outer former.
- Screw drive bolt into parting tool to remove the outer former.

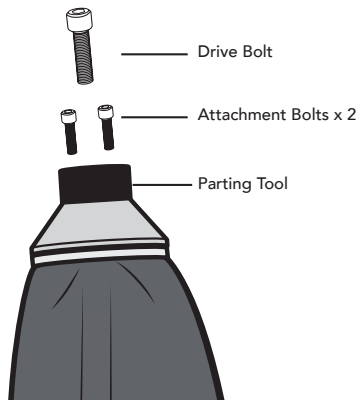

- 19** Gently tap center bolt to remove inner tool form and plug.

**Note:** Be careful not to damage threads on the bolt.



- 20** Prepare Collar and Slider Base:

- Grind to silicone in both the collar and the slider dummies and remove.
- Smooth edges.
- Trim tube ends in both Lamination and Slider Collars. Remove any clay debris.

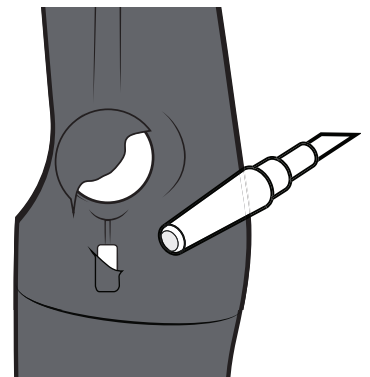

## Detailed Fabrication Instructions (continued):

### 21 Install RevoLock Slider:

- a. Ensure carbon edge surrounding Lamination Collar and Slider Collar cavity is smooth - sand with wet/dry sand paper.

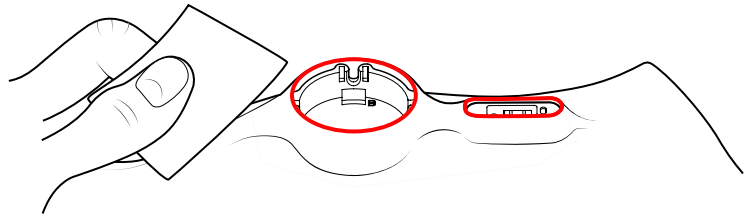

- b. Insert wire on Slider into the Slider Collar and into tubing. Push the wire through the tubing until it exits the reel collar.

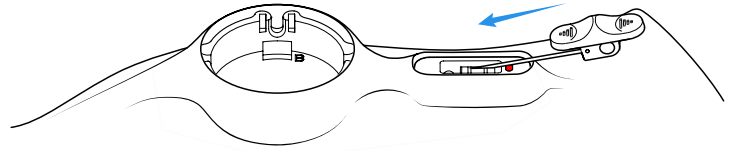

- c. Push the Switch down into the Slider Base until it "clicks".

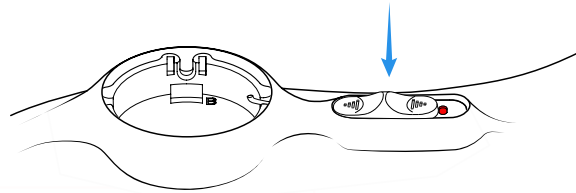

- d. **VERY IMPORTANT STEP:** Ensure that the Switch is in the unlocked/open position with the red indicator not visible.

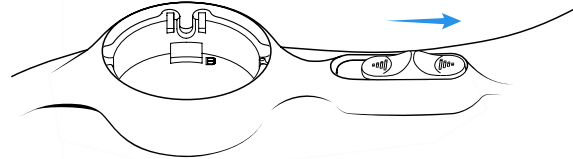

- e. **VERY IMPORTANT STEP:** Mark the Lock Wire at the inside diameter of the reel Lamination Collar with a permanent marker.

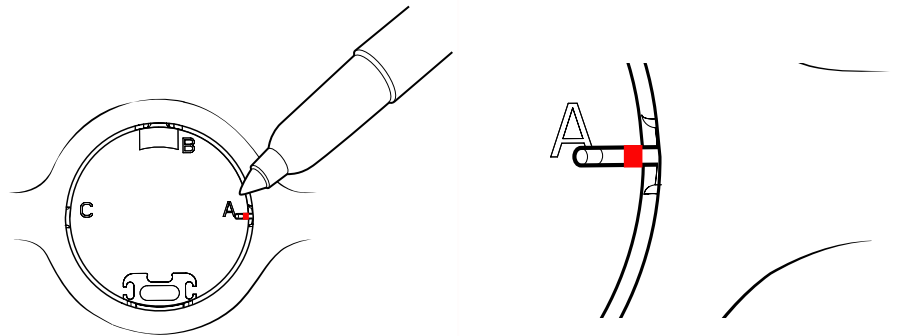

- f. Move Switch into the locked position, with the red pill shape showing.

**Step 1** Cut Lock Wire at the mark.

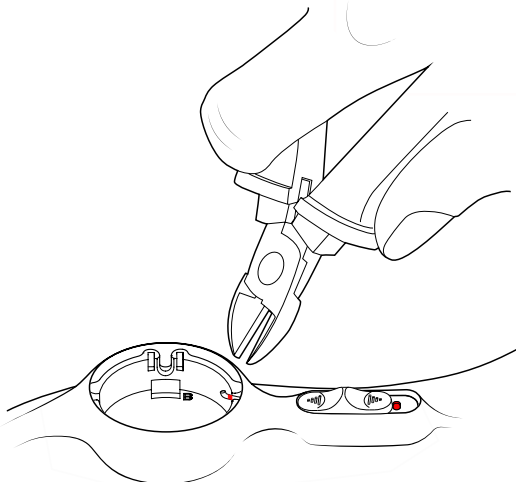

**Step 2**

Sand/file smooth to remove any burrs.

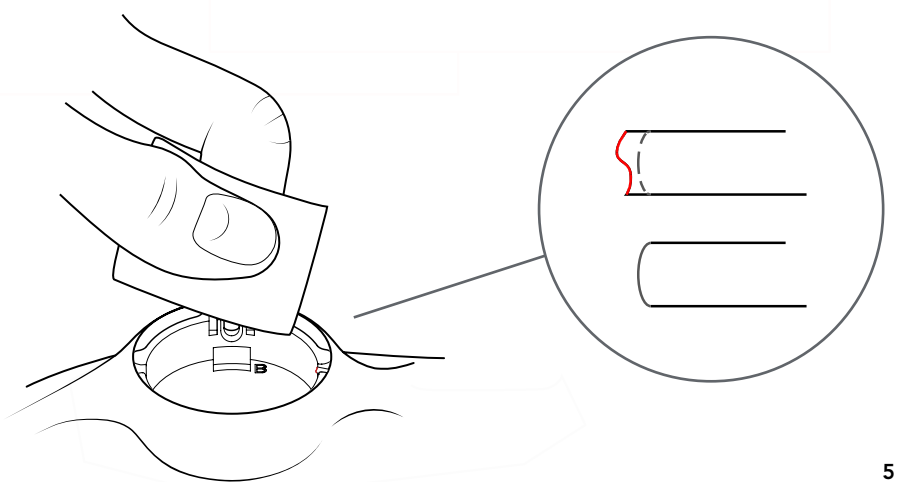

## Detailed Fabrication Instructions (continued):

### 22 Install 4-Hole Housing:

a. Insert distal RevoLock housing into socket.

**Note:** Align bottom channel to fit over the tubing.

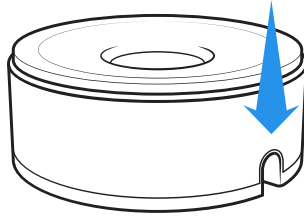

b. Attach alignment hardware and torque to spec (12 Nm).

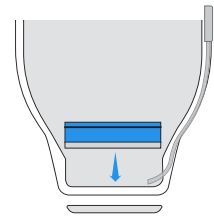

### 23 Lace the device.

Use the lace feeder to feed the lace through tubing starting at the collar.

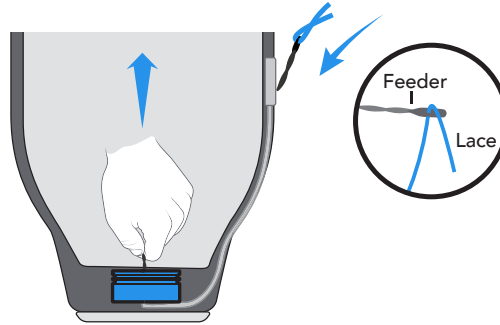

### 24 Attach lace to the Click Reel.

#### Step 1

Ensure that the reel is ready for lacing. Both lock plugs should be in place. The **green marks** on the spool should align with the **green marks** on the washer. If necessary, turn dial to align green marks. Use **Lace Port C**.

Adjust alignment by turning dial

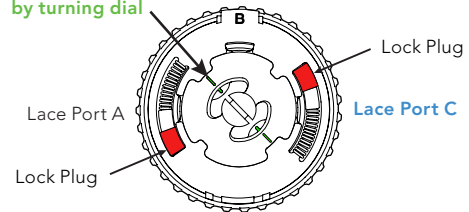

#### Step 2

Lace the reel using the plastic lace feeder through **Lace Port C**.

#### Pro Tips:

1. Slightly bend the tip of the lace feeder.
2. Once inserted into lace hole, twist lace feeder to help exit the lace hole.

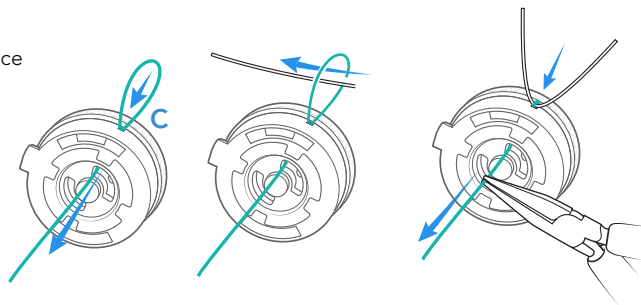

#### Step 3

Tie a **double overhand** knot for the HC Lace. Trim tail to <5mm and lightly burn the end of the tail.

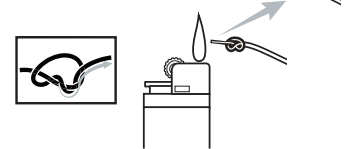

#### Step 4

Pull lace to seat knot in the far lace pocket, on the opposite side of the **green marker**.

Completely push knot into the cavity with a #1 flathead screwdriver:

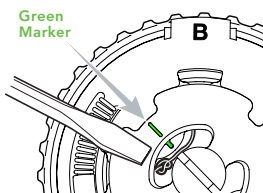

#### Step 5 Engage Shift Mode.

Remove **both** Red Lock Plugs to engage the Shift Mode of the reel.

**Pro Tip:** Keep the Red Lock Plugs for future use.

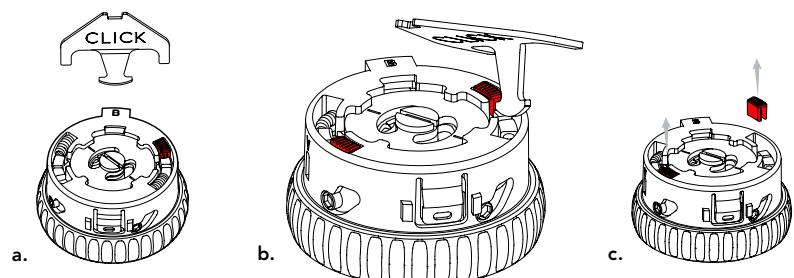

## Detailed Fabrication Instructions (continued):

### 25 Install the Click Reel.

a. Insert the foot of the reel into collar.

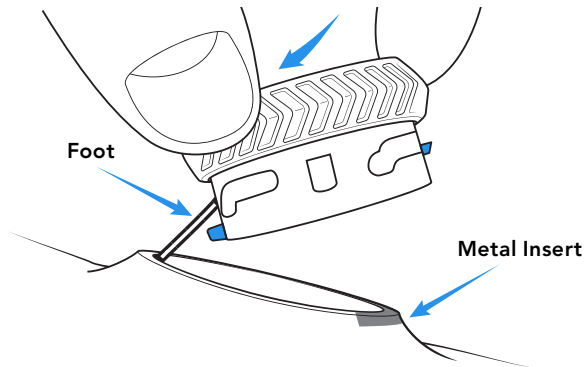

b. Press the reel firmly into the collar (you should hear a "CLICK" when secure).

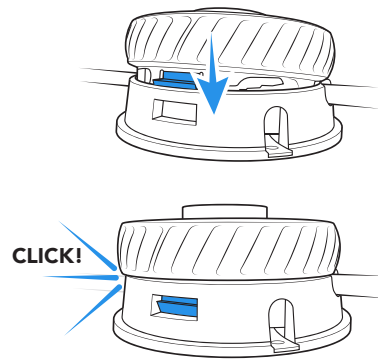

### 26 Attach Lace to Snap:

a. Determine lace length for the user to easily connect snap parts, and mark the lace.

**Note:** Max lace length from distal housing = 45 cm.



Select Snap



b. Connect the lace to the CURRENT snap:

Using a lace feeder, insert lace and tie single fisherman's knot. Lightly burn the end of the knot to ensure it does not slip.

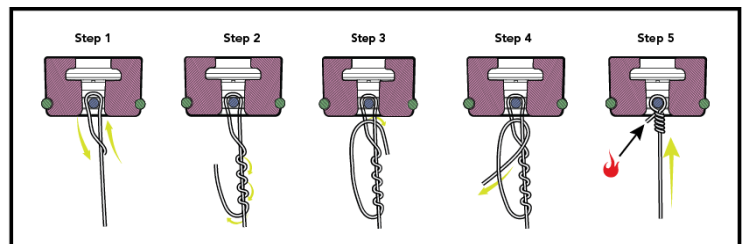

b. Connect the lace to the LEGACY snap:

Thread lace up through the center hole from the bottom of the snap base. Then thread lace down through the knot chamber. Tie a **double overhand** knot. Seat the knot into the knot chamber by pulling on the lace. Seal the hole with a drop of glue.

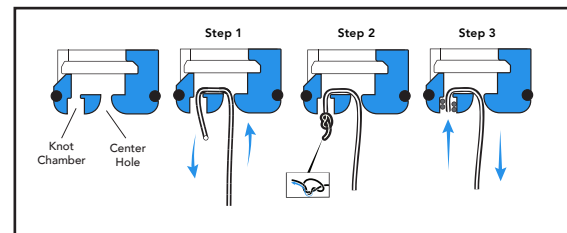

27 Apply medium thread lock to the insert threads and attach to the liner.

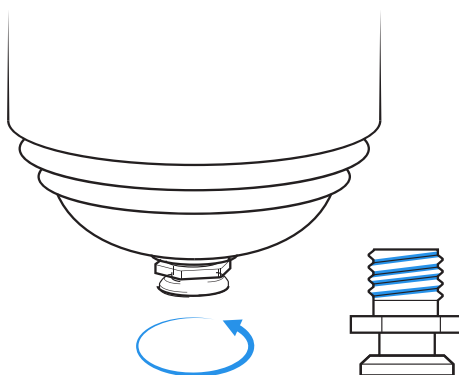

28 Test the snap connection by attaching and detaching 2-3 times.

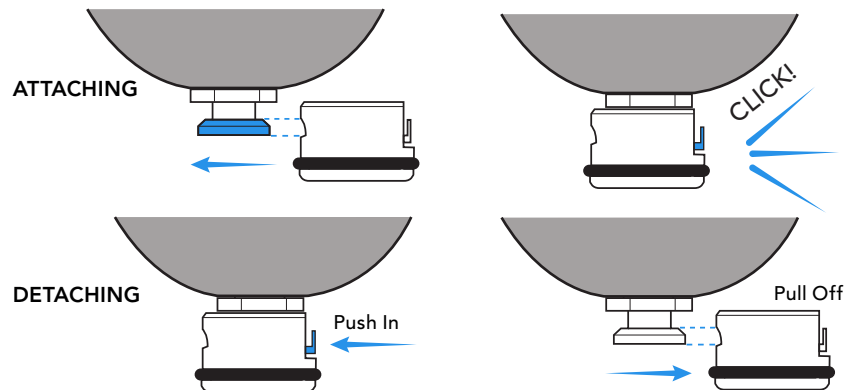

**Test system for proper function:**

Cycle the system 3 times before delivering to verify proper function of the reel.

### 29 Important.

As a final step of fabrication, attach the patient **Instructions For Use** hangtag on dial.

## How to replace the Lock Wire:

This process is **ONLY** needed if the Lock Wire is trimmed short and does not engage the Shift Ring. Replace it with the second Lock Wire included in the kit.

### Step 1

Put the slider in the locked position with the red pill shape showing completely.

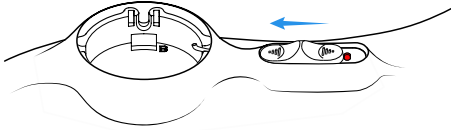

### Step 2

Place a #1 flathead screwdriver on top of the base behind the slider and on top of the red pill shape.

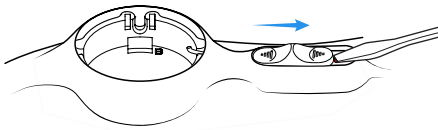

### Step 3

Push the Switch into the unlocked position, ramping it up the flathead screwdriver face until the Switch pops out of the Slider Base.

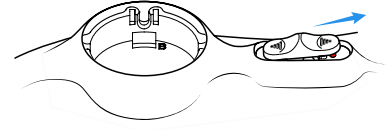

### Step 4

Push the pin out of the Switch body from one side only.

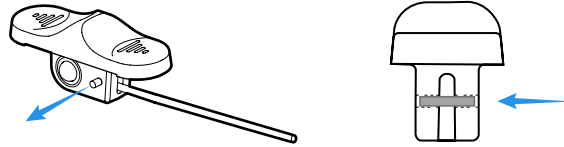

### Step 5

Once the pin is exposed enough to grab with pliers, pull the pin almost all of the way out, but leaving it in one of the side walls.



### Step 6

Remove and discard old Lock Wire & put new Lock Wire in pocket.

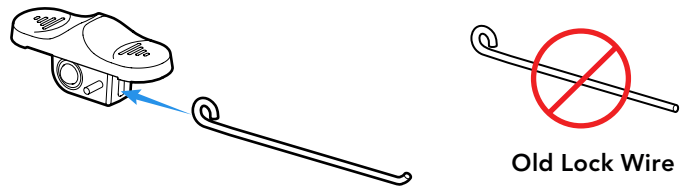

### Step 7

Push the pin back through second wall with a flat head screwdriver, capturing the Lock Wire and fastening it in place. The Lock Wire should still be able to rotate, but not pull out of the pocket. Make sure that the pin is not proud of the wall surface, otherwise it will drag on the inside of the Slider Base and cause a malfunction.

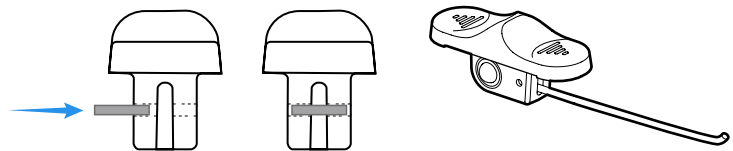

### Step 8

Reinsert Lock Wire into tubing and Switch into Slider Base (see step 6 above).

**\*If you lose the pin**, use the discarded locking wire as a replacement. Cut the old locking wire cleanly and insert into side wall pin hole. Push through until it starts to enter the second wall. Trim old locking wire and push the pin the rest of the way into the first wall.

# How to use the Click Reel

The reel can operate in either Power Mode or Shift Mode.  
If you want to change between modes, see our video on the process here: <https://vimeo.com/786989811>

- 1 Turn reel clockwise to quickly take up lace.
 

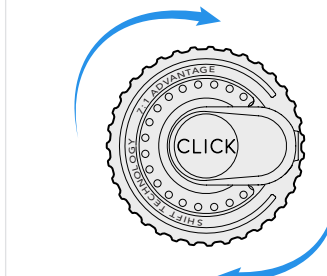
Reel will operate silently while taking up lace
- 2 Continue to turn the dial. It will automatically shift from "silent" to "clicking".
 

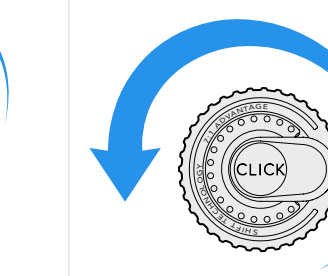
Once clicking, the reel will hold lace tension and wind up lace at a higher power
- 3 Micro-adjust by turning forward or backward.
 
- 4 To fully release lace, unwind counterclockwise until "clicking" stops. Lace will then freely release from the reel.
 

## To remove the Click Reel:

- a. Locate the metal insert.
- b. Insert a small flathead screwdriver between the metal insert and the reel body.
- c. Gently pry the reel upwards.

See [clickmedical.co/instructions](http://clickmedical.co/instructions) for detailed instructions for replacing/re-lacing a reel.

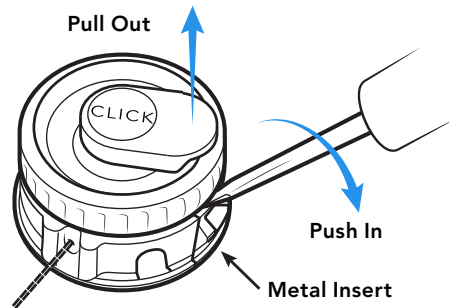

## How to use the Slider:

- 1 Push out, Slider is **unlocked**.
  - a. Allows for the standard function of the Reel with full release of the lace.
- 2
  - a. Turn the dial clockwise until the limb is fully seated and reel has fully shifted into Power Mode. Insert a small flathead screwdriver between the metal insert and the reel body.
  - b. While the reel is fully shifted, engage the Slider by pushing it towards the reel, until the red mark appears.
  - c. Once locked, the reel will micro-adjust in both directions, click by click, but will not allow for full release of the lace.

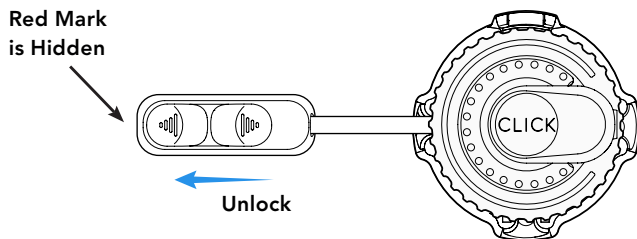

**Pro Tip:** If the patient can't fully seat into the socket, they can still stay locked into the device. Once the reel is fully shifted into Power Mode, engage the slider and the user is securely connected to the socket.

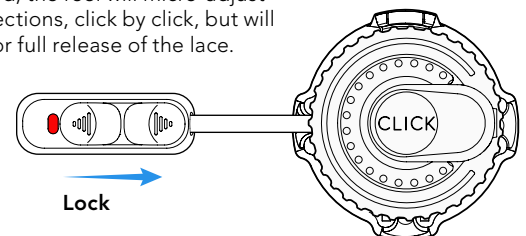

**Pro Tip:** Increased lace tension will cause the reel to shift faster. The user can achieve this by pulling their limb away while donning the socket.

## How to operate the Snap to connect the liner:

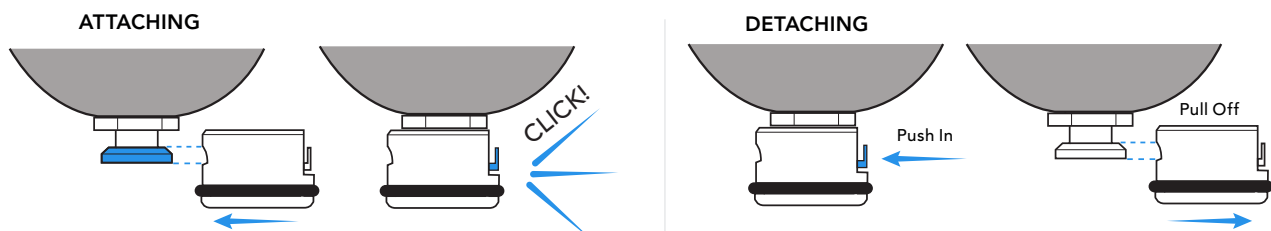

# At delivery of device with patient present, scan *Instructions For Use* Hangtag. Please review with your patient how to use the Click Reel and to care for and maintain their RevoLock system.

## Regularly inspect your RevoLock system.



### Inspect lace:

- ✓ Check for wear or damage routinely
- ✓ Replace at any sign of wear
- ✓ Replace lace every 6 months



This product is waterproof and submersible. Rinse with fresh water after use in saltwater, sand, or mud.

**UK REP**

MDSS-UK RP LIMITED, 6 Wilmslow Road  
Rusholme, M14 5TP Manchester  
United Kingdom

**CH REP**

MDSS CH GmbH, Laurenzenvorstadt 61  
5000 Aarau, Switzerland

**MD**

MDSS GmbH, Schiffgraben 41  
30175 Hannover, Germany

**EC REP**

