

Visit [www.clickacademy.co](http://www.clickacademy.co) for important video education on Click Reels and RevoLock operation



### Advisories

Must be installed by a licensed professional.

Lace will wear:

- Routinely check for wear or damage.
- Look for broken fibers around areas of high wear.
- Replace lace if a significant amount of fibers are broken.
- Proactively replace lace every 6 months.
- Loss of suspension can occur if lace fails.
- Keep lace away from open flame and sharp edges.

Secure threaded insert to liner with medium thread lock.

Secure snap to threaded insert before tensioning system.

**Weight limit:** 300lbs/135kg

See instructions in other languages: [clickmedical.co/instructions](http://clickmedical.co/instructions)

### GUARANTEE

The Click Reel is guaranteed to last the life of the device into which it is originally installed. Registration of the Click Reel is required at the time of original device delivery. To register: [clickmedical.co/contact-us/cr-registration/](http://clickmedical.co/contact-us/cr-registration/)

### WARRANTY

For warranty information on all of Click Medical's products: [clickmedical.co/terms/#warranty](http://clickmedical.co/terms/#warranty)

### U.S. Customers:

Contact [Help@ClickMedical.co](mailto:Help@ClickMedical.co)

Tel: +1-970-670-7012

### International Customers:

Please contact your local distributor.

**Click Medical products are patent protected.**

For full list see [www.clickmedical.co/patents](http://www.clickmedical.co/patents)

## RevoLock Align Kit Contents:

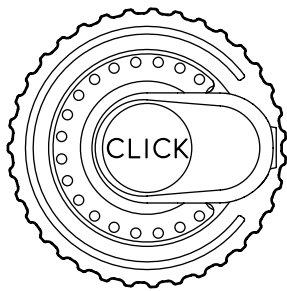

Click Reel

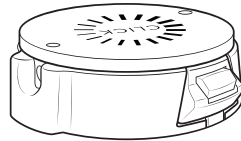

Lamination Collar & Dummy

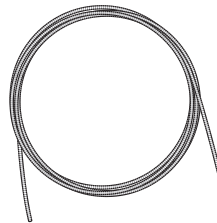

0.5m Lamination Tube

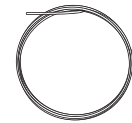

2.0m HC Lace

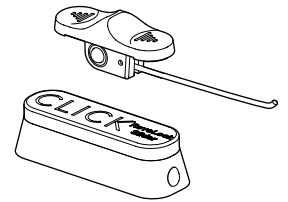

RevoLock Slider

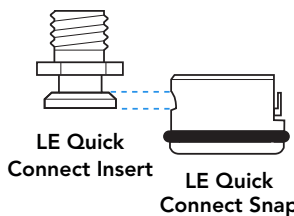

LE Quick Connect Insert

LE Quick Connect Snap

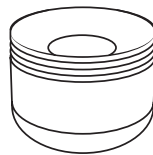

Align Housing & Fabrication Post

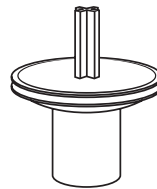

Metal Lace Feeder

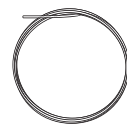

Reel Tool

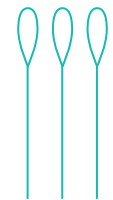

Plastic Lace Feeder x 3

## Fabrication Overview:

1. Secure lamination post to model.
2. Slide align housing over tube, then insert tube end onto distal end of fabrication post.
3. Slide align housing onto fabrication post.
4. Apply PVA bag.
5. Apply inner fabric layers.
6. Place tube and collar in desired location.
7. Apply outer fabric layers.
8. Perform 1st lamination.
9. Transfer alignment (if making socket adjustable, add RevoFit® kit now).
10. Perform 2nd lamination.
11. Remove model.
12. Lace socket.
13. Attach lace to both the snap and the Click Reel.
14. Attach snap insert to liner.
15. Install Click Reel into collar.
16. Attach threaded insert to snap and test for function.

## Detailed Fabrication Instructions: Single or Two Stage Lamination

**⚠ DO NOT EXCEED 15 inHG OF VACUUM PRESSURE DURING LAMINATION**

### 1 Apply lamination post to model:

- Drill 9 mm hole into distal end of model.
- Flatten end of model.
- Backfill hole with plaster or adhesive, to secure post to model.

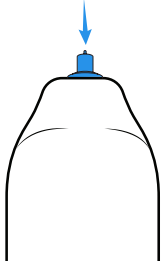

### 2 Expose 8-10 cm of bare tubing, then slide the tube through align housing onto the post.

Pack the end of tube with clay and insert firmly onto the distal end nipple.

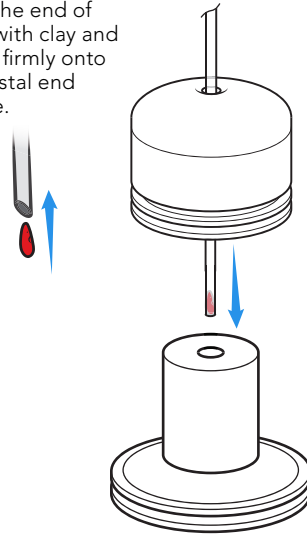

### 3 Slide distal housing over tube and onto post:

**Note:** Housing will secure the tube to the post and create an air-tight seal.

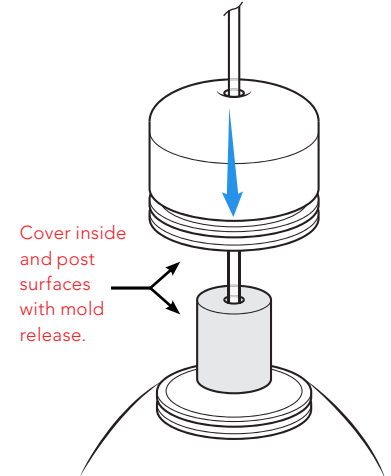

### 4 Apply PVA bag:

Tie PVA bag into the bottom groove of the distal housing and trim excess PVA.

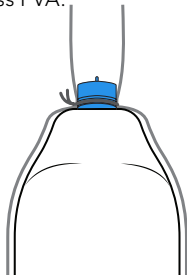

### 5 Apply inner material layup:

Tie inner fabric layers around tube and reflect over the mold. Do not pull tube out of the post.

### 6 Mount the lamination collar in the desired location:

Glue the collar to the outer fabric layer with **Lace Port C** oriented towards the distal end.

### 7 Install the tubing:

- Carefully bend the tubing **-WITHOUT KINKING IT-** toward the collar.
- Measure the distance to the collar, and add 2 cm.
- Cut the tube to length, pack with clay and insert into the collar (**Lace Port C**). Leave 20-30mm of space from the proximal end of the collar to the trim line to allow for the installation of the Slider in Step 8.

**-- DO NOT KINK THE TUBE --**

If the tube kinks, you must replace with a new piece.

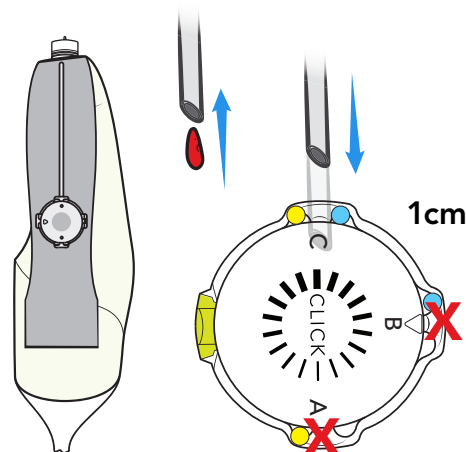

## Detailed Fabrication Instructions (continued):

### 8 Install RevoLock Slider Base and Tubing:

**Purpose:** The RevoLock Slider locks the reel into Power Mode and prevents unintentional full release of lace.

a. Plug both ends of Slider Tube with clay.



b. Insert tube into Slider Base.  
Insert fully - at least 1cm.

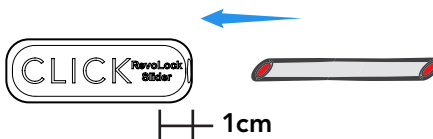

c. Insert free end of tube into Lamination Collar opposite of the tubing inserted in step 6 (Lace Port A).  
Insert fully - at least 1cm.

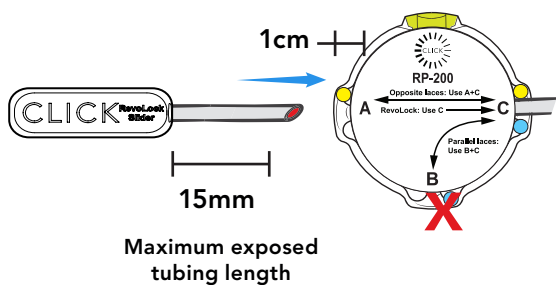

d. Place Lamination Collar and Slider Base in desired location.

**Pro Tip:**  
Use light spray adhesive if necessary.

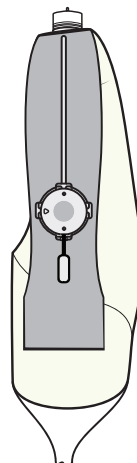

e. Use additional material to fill in under tubing for support.



9 Apply outer layers of material.  
If doing single stage lamination, add attachment hardware now.

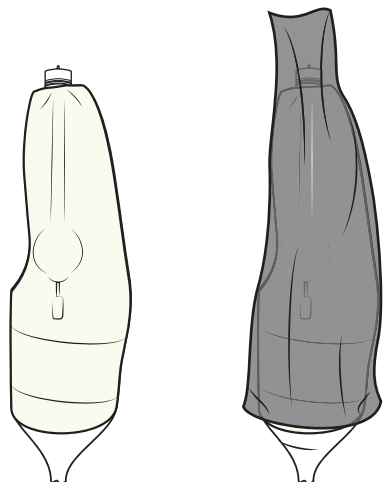

10 Perform 1st lamination.



11 If doing two stage lamination, transfer socket alignment now.

**Optional:** If also adding RevoFit adjustability, install those components now.

12 Perform 2nd lamination.

13 Prepare collar.

- Grind to silicone in both the collar and the slider dummies and remove.
- Smooth edges.
- Trim the tube in both the Reel Collar and the Slider Collar.

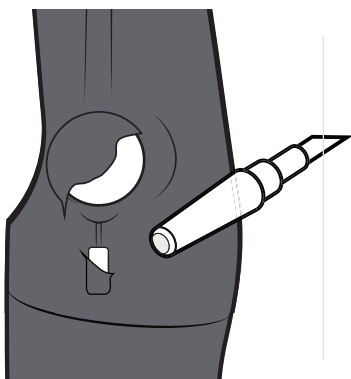

14 Remove model.

Remove lamination post from distal housing.

**Note:** Make sure silicone dummy is removed from the collar before attempting to remove the post from the distal housing.

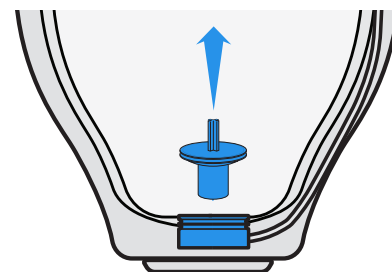

## Detailed Fabrication Instructions (continued):

### 15 Install RevoLock Slider:

- a. Ensure carbon edge surrounding Lamination Collar and Slider Collar cavity is smooth  
- sand with wet/dry sand paper.

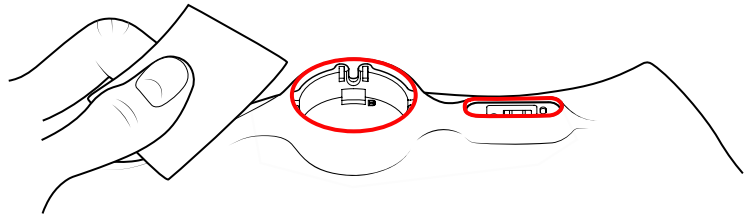

- b. Insert wire on Slider into the Slider Collar and into tubing. Push the wire through the tubing until it exits the reel collar.

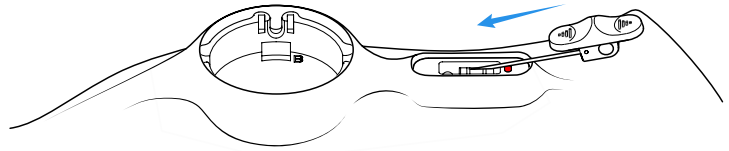

- c. Push the Switch down into the Slider Base until it "clicks".

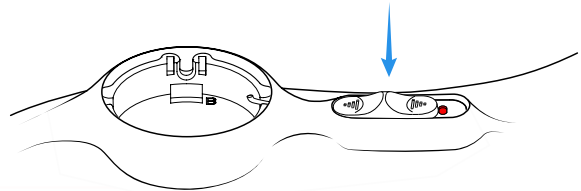

- d. **VERY IMPORTANT STEP:** Ensure that the Switch is in the unlocked/open position with the red indicator not visible.

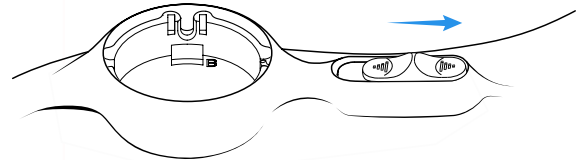

- e. **VERY IMPORTANT STEP:** Mark the Lock Wire at the inside diameter of the reel Lamination Collar with a permanent marker.

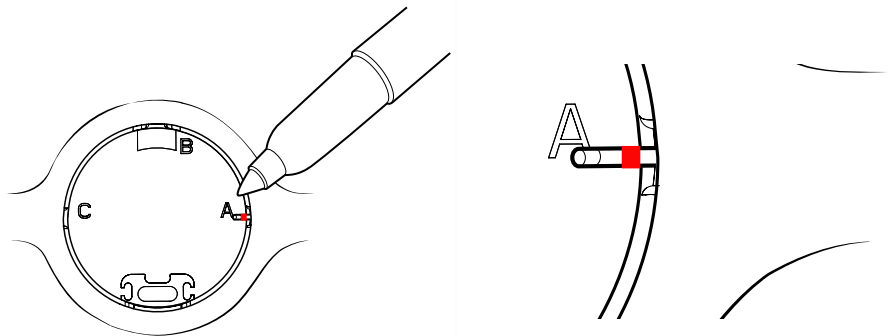

- f. Move Switch into the locked position, with the red pill shape showing.

**Step 1** Cut Lock Wire at the mark.

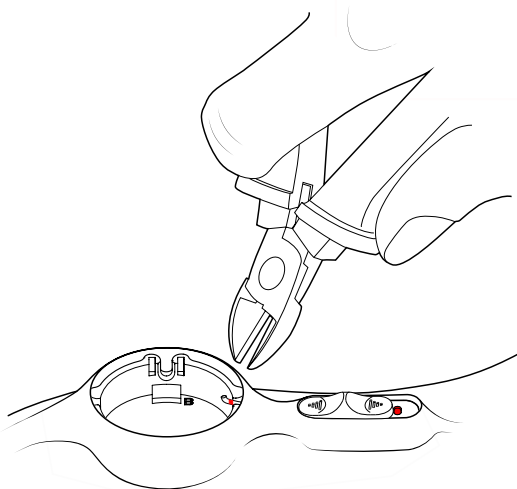

**Step 2** Sand/file smooth to remove any burrs.

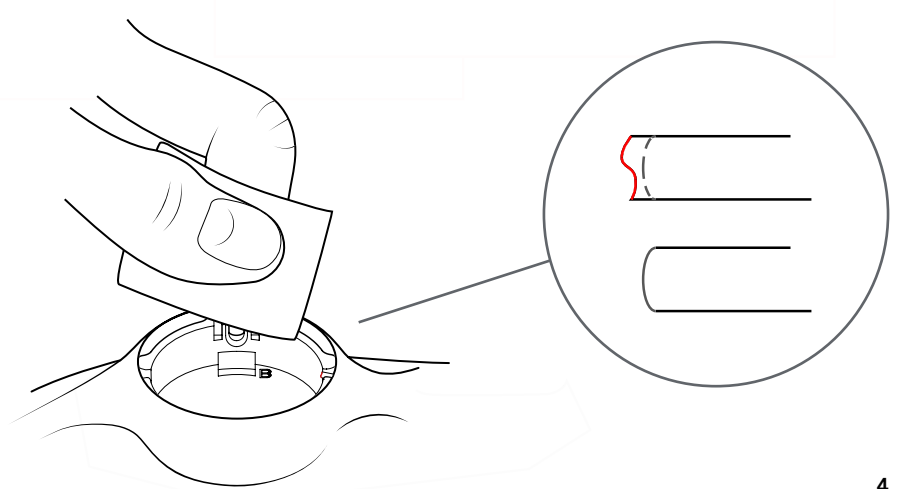

## Detailed Fabrication Instructions (continued):

### 16 Lace the device.

Use the lace feeder to feed the lace through tubing starting at the collar.

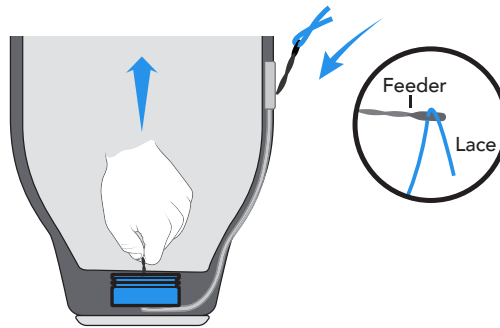

### 17 Attach lace to the Click Reel.

#### Step 1

Ensure that the reel is ready for lacing. Both lock plugs should be in place. The **green marks** on the spool should align with the **green marks** on the washer. If necessary, turn dial to align green marks. Use **Lace Port C**.

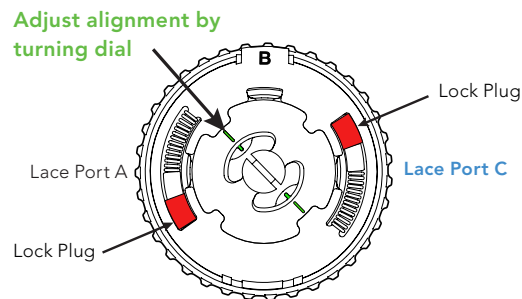

#### Step 2

Lace the reel using the plastic lace feeder through **Lace Port C**.

#### Pro Tips:

1. Slightly bend the tip of the lace feeder.
2. Once inserted into lace hole, twist lace feeder to help exit the lace hole.

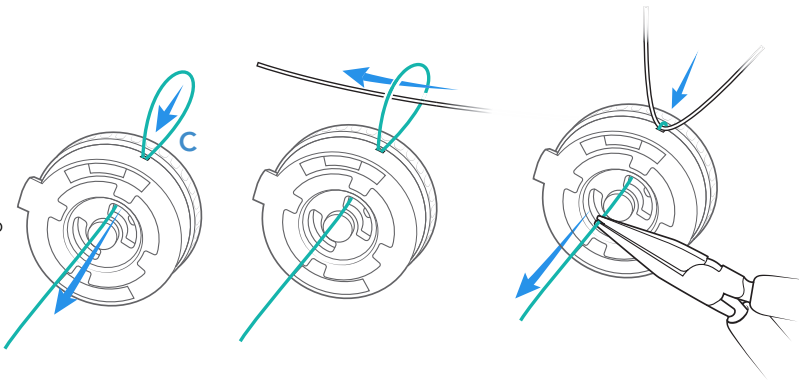

#### Step 3

Tie a **double overhand** knot for the HC Lace. Trim tail to <5mm and lightly burn the end of the tail.

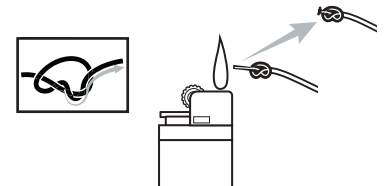

#### Step 4

Pull lace to seat knot in the far lace pocket, on the opposite side of the **green marker**.

Completely push knot into the cavity with a #1 flathead screwdriver:

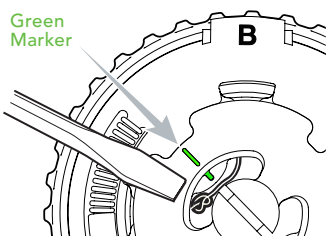

#### Step 5 Engage Shift Mode.

Remove **both** Red Lock Plugs to engage the Shift Mode of the reel.

**Pro Tip:** Keep the Red Lock Plugs for future use.

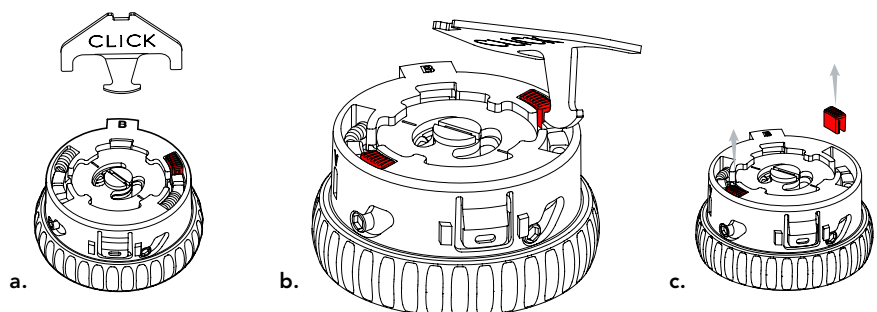

## 18 Install the Click Reel.

a. Insert the foot of the reel into collar.

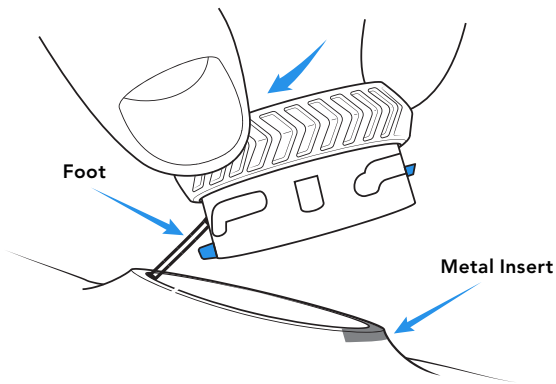

b. Press the reel firmly into the collar (you should hear a "CLICK" when secure).

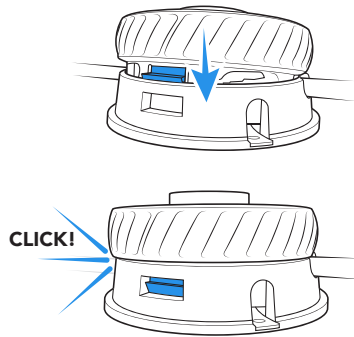

## 19 Attach Lace to Snap:

a. Determine lace length for the user to easily connect snap parts, and mark the lace.

**Note:** Max lace length from distal housing = 45cm.

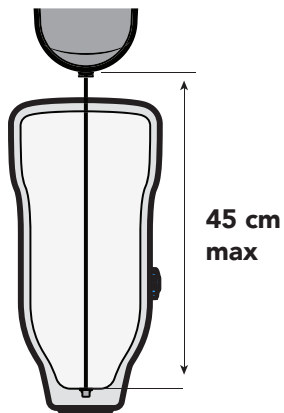

Select Snap



b. Connect the lace to the CURRENT snap:

Using a lace feeder, insert lace and tie single fisherman's knot. Lightly burn the end of the knot to ensure it does not slip.

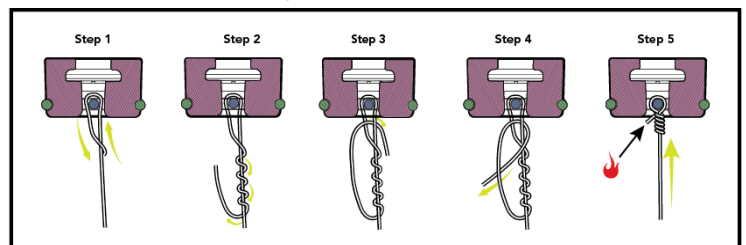

b. Connect the lace to the LEGACY snap:

Thread lace up through the center hole from the bottom of the snap base. Then thread lace down through the knot chamber. Tie a **double overhand** knot. Seat the knot into the knot chamber by pulling on the lace. Seal the hole with a drop of glue.

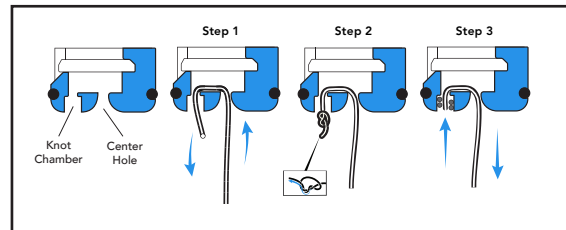

20 Apply medium thread lock to the insert threads and attach to the liner.

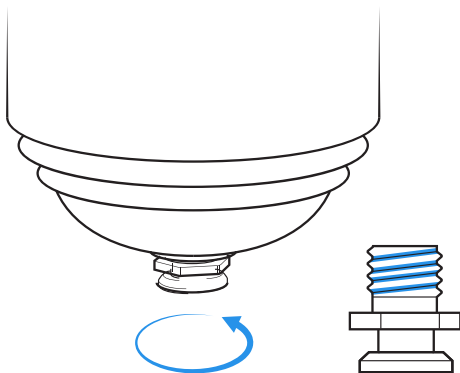

21 Test the snap connection by attaching and detaching 2-3 times.

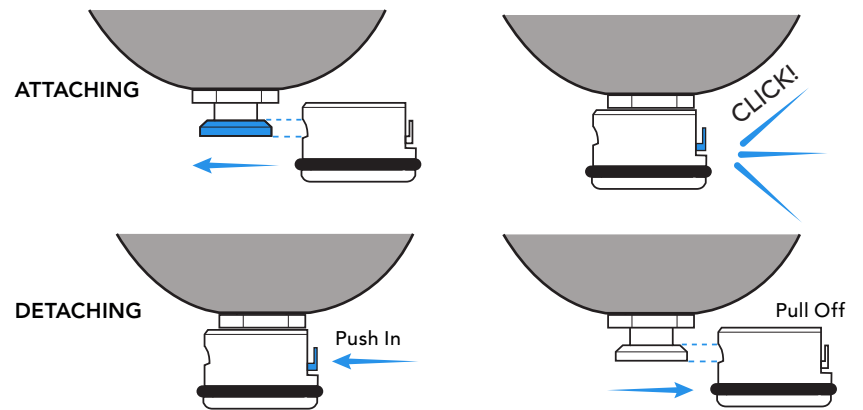

22 Test system for proper function: Cycle the system 3 times before delivering to verify proper function of the reel.

23 **Important.** As a final step of fabrication, attach the patient **Instructions For Use** hangtag on dial.

## How to replace the Lock Wire:

This process is **ONLY** needed if the Lock Wire is trimmed short and does not engage the Shift Ring. Replace it with the second Lock Wire included in the kit.

### Step 1

Put the slider in the locked position with the red pill shape showing completely.

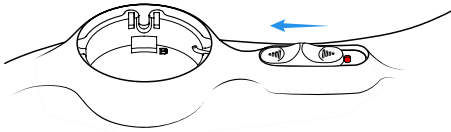

### Step 2

Place a #1 flathead screwdriver on top of the base behind the slider and on top of the red pill shape.

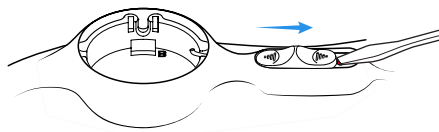

### Step 3

Push the Switch into the unlocked position, ramping it up the flathead screwdriver face until the Switch pops out of the Slider Base.

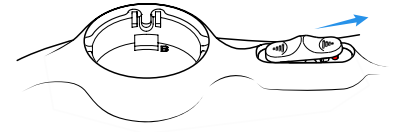

### Step 4

Push the pin out of the Switch body from one side only.

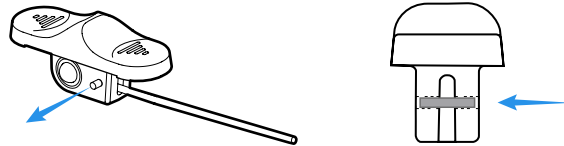

### Step 5

Once the pin is exposed enough to grab with pliers, pull the pin almost all of the way out, but leaving it in one of the side walls.



### Step 6

Remove and discard old Lock Wire & put new Lock Wire in pocket.

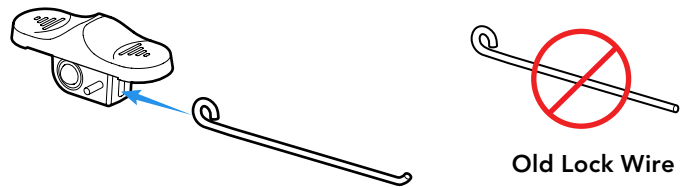

### Step 7

Push the pin back through second wall with a flat head screwdriver, capturing the Lock Wire and fastening it in place. The Lock Wire should still be able to rotate, but not pull out of the pocket. Make sure that the pin is not proud of the wall surface, otherwise it will drag on the inside of the Slider Base and cause a malfunction.

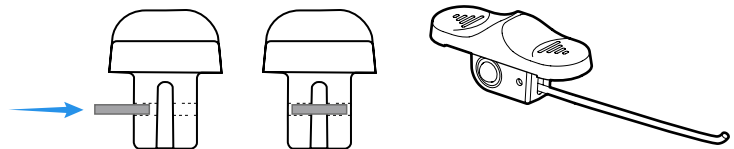

### Step 8

Reinsert Lock Wire into tubing and Switch into Slider Base (see step 6 above).

**\*If you lose the pin**, use the discarded locking wire as a replacement. Cut the old locking wire cleanly and insert into side wall pin hole. Push through until it starts to enter the second wall. Trim old locking wire and push the pin the rest of the way into the first wall.

# How to use the Click Reel

The reel can operate in either Power Mode or Shift Mode.  
If you want to change between modes, see our video on the process here: <https://vimeo.com/786989811>

- 1** Turn reel clockwise to quickly take up lace.

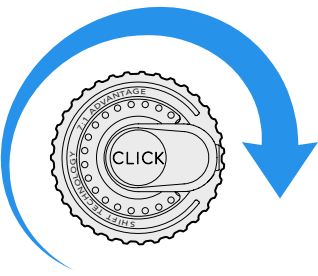

Reel will operate silently while taking up lace
- 2** Continue to turn the dial. It will automatically shift from "silent" to "clicking".

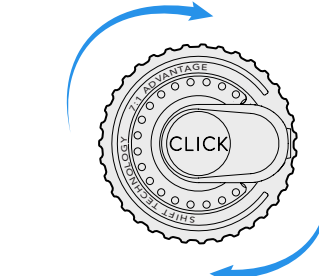

Once clicking, the reel will hold lace tension and wind up lace at a higher power
- 3** Micro-adjust by turning forward or backward.

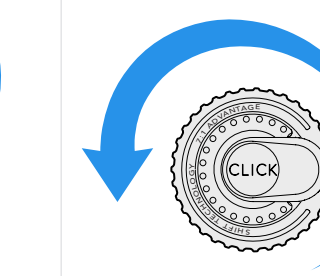

- 4** To fully release lace, unwind counterclockwise until "clicking" stops. Lace will then freely release from the reel.



## To remove the Click Reel:

- a. Locate the metal insert.
- b. Insert a small flathead screwdriver between the metal insert and the reel body.
- c. Gently pry the reel upwards.

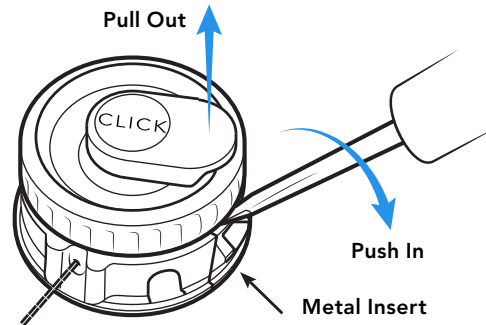
See [clickmedical.co/instructions](http://clickmedical.co/instructions) for detailed instructions for replacing/re-lacing a reel.



## How to use the Slider:

- 1** Push out, Slider is **unlocked**.

  - a. Allows for the standard function of the Reel with full release of the lace.

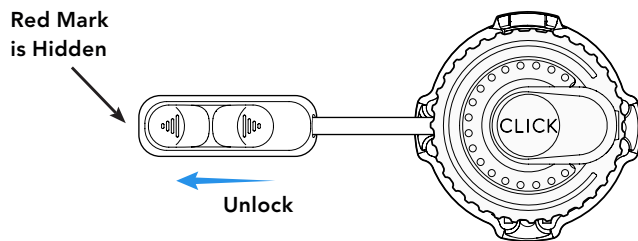

**Pro Tip:** If the patient can't fully seat into the socket, they can still stay locked into the device. Once the reel is fully shifted into Power Mode, engage the slider and the user is securely connected to the socket.

- 2**

  - a. Turn the dial clockwise until the limb is fully seated and reel has fully shifted into Power Mode. Insert a small flathead screwdriver between the metal insert and the reel body.
  - b. While the reel is fully shifted, engage the Slider by pushing it towards the reel, until the red mark appears.
  - c. Once locked, the reel will micro-adjust in both directions, click by click, but will not allow for full release of the lace.

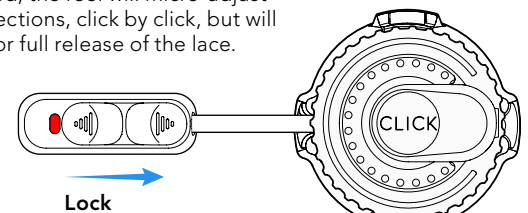

**Pro Tip:** Increased lace tension will cause the reel to shift faster. The user can achieve this by pulling their limb away while donning the socket.

## How to operate the Snap to connect the liner:

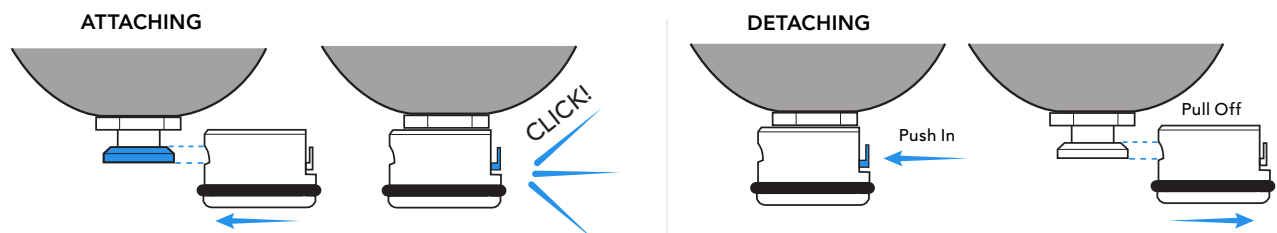

**At delivery of device with patient present, scan *Instructions For Use* Hangtag. Please review with your patient how to use the Click Reel and to care for and maintain their RevoLock system.**

**Regularly inspect your RevoLock system.**



**Inspect lace:**

- ✓ Check for wear or damage routinely
- ✓ Replace at any sign of wear
- ✓ Replace lace every 6 months



This product is waterproof and submersible. Rinse with fresh water after use in saltwater, sand, or mud.

<b>UK</b>	<b>REP</b>	MDSS-UK RP LIMITED, 6 Wilmslow Road Rusholme, M14 5TP Manchester United Kingdom
-----------	------------	---

<b>CH</b>	<b>REP</b>	MDSS CH GmbH, Laurenzenvorstadt 61 5000 Aarau, Switzerland
-----------	------------	---

<b>MD</b>	MDSS GmbH, Schiffgraben 41 30175 Hannover, Germany
-----------	---

<b>EC</b>	<b>REP</b>	
-----------	------------	---



Click Medical, LLC, 1205 Hilltop Parkway, W101  
Steamboat Springs, CO 80487, USA +1-970-670-7012